Data Book

T_wAVS_0521_EN

w-AV S

45-234 kW

Air conditioners for IT Cooling for chilled water feeding.



The picture of the unit is indicative and may vary depending on the model

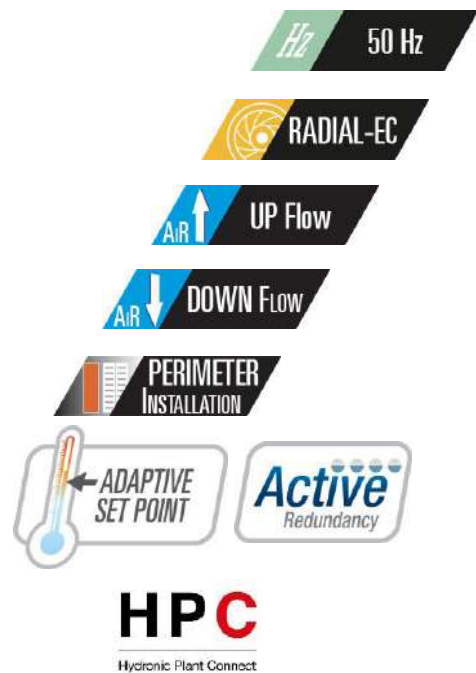

- Perimeter installation
- Variable air flow and water flow
- Air delivery from the bottom or from the top

- Plug fans with EC electric motor
- 2-way chilled water valve
- Air suction temperature up to 45°C

INDEX

CERTIFICATIONS	4
GENERAL CHARACTERISTICS	5
PRODUCT FEATURES AND BENEFITS	5
INSTALLATION	6
MODEL IDENTIFICATION	6
TRANSPORT AND STORAGE TEMPERATURE	6
WORKING LIMITS	7
LIMIT OF CHILLED WATER TEMPERATURE AT THE UNIT'S INLET	7
MAIN COMPONENTS	8
OPTIONAL ACCESSORIES	9
TECHNICAL DATA	12
HYDRAULIC DIAGRAM	14
2-WAY BALL VALVE FOR CHILLED WATER FLOW CONTROL	14
ACOUSTIC DATA	15
ELECTRICAL DATA	15
WATER QUALITY OF THE HYDRAULIC CIRCUITS	16
ANTIFREEZE MIXTURES	16
MICROPROCESSOR CONTROL SYSTEM	17
ACTIVE REDUNDANCY	19
TEMPERATURE PROBE ON AIR SUCTION / DELIVERY	20
OPTIONAL ACCESSORIES: P121 – FRONT AIR INTAKE+BOTTOM PANEL	20
OPTIONAL ACCESSORIES: P122 - BOTTOM AIR INTAKE+BLIND PANELS	20
OPTIONAL ACCESSORIES: A548 - CONSTANT PREVALENCE	21
OPTIONAL ACCESSORIES: P091 – BACK-UP MODULE CONTROLLER	21
OPTIONAL ACCESSORIES: 383 – NUMBERED WIRINGS + UK REQUESTS	21
OPTIONAL ACCESSORIES: 4181 – SERIAL CARD MODBUS	21
OPTIONAL ACCESSORIES: 4182 – SERIAL CARD LON	21
OPTIONAL ACCESSORIES: 4184 – SERIAL CARD BACNET MS/TP RS485	22
OPTIONAL ACCESSORIES: 4185 – SERIAL CARD BACNET OVER IP	22
OPTIONAL ACCESSORIES: A491 – WATER LEAKAGE DETECTOR	22
OPTIONAL ACCESSORIES: A492 – WATER LEAKAGE DETECTOR + ADDITIONAL DETECTOR	22
OPTIONAL ACCESSORIES: A501 - CLOGGED FILTERS SENSOR	22
OPTIONAL ACCESSORIES: A511 – SMOKE DETECTOR	23
OPTIONAL ACCESSORIES: A521 – FIRE DETECTOR	23
OPTIONAL ACCESSORIES: A822 – ADAPTIVE SET-POINT	23
OPTIONAL ACCESSORIES: 5891 – CONTROL UNIT VIA KIPLINK	24
OPTIONAL ACCESSORIES: 6461 – HPC	25
OPTIONAL ACCESSORIES: A35B – GRAPHIC DISPLAY “EVOLUTION TOUCH”	27
OPTIONAL ACCESSORIES: A352 - NO DISPLAY	27
OPTIONAL ACCESSORIES: P141 – ANALOGUE SET-POINT COMPENSATION	28
OPTIONAL ACCESSORIES: A842 – NETWORK ANALYZER	28
OPTIONAL ACCESSORIES: A812 – FREE-COOLING DIRECT CONTROL	28
OPTIONAL ACCESSORIES: P021 – 2-WAY BALL BYPASS VALVE (MAIN CIRCUIT)	28
OPTIONAL ACCESSORIES: P131 – HOT WATER COIL + 2WAY VALVE	29
OPTIONAL ACCESSORIES: A431 - ELECTRIC HEATERS	31
OPTIONAL ACCESSORIES: A432 - EXTRA POWER ELECTRIC HEATERS	31
OPTIONAL ACCESSORIES: 4301 – STEAM HUMIDIFIER 3KG/H	32
OPTIONAL ACCESSORIES: 4303 – STEAM HUMIDIFIER 8KG/H	32
OPTIONAL ACCESSORIES: 4305 – STEAM HUMIDIFIER 15KG/H	32
OPTIONAL ACCESSORIES: P051 – DEHUMIDIFICATION FUNCTION	33
OPTIONAL ACCESSORIES: P161 - T/RH AIR INTAKE SENSOR	33

OPTIONAL ACCESSORIES: P071 / P072 / P073 / P074 - REMOTE T/RH PROBE	33
OPTIONAL ACCESSORIES: 4666 – EXTERNAL AIR PROBE	34
OPTIONAL ACCESSORIES: P111 – DUAL POWER SUPPLY	34
OPTIONAL ACCESSORIES: P112 – DUAL POWER SUPPLY + OPTIONAL	34
OPTIONAL ACCESSORIES: P113 – DUAL POWER SUPPLY KIT	34
OPTIONAL ACCESSORIES: P114 – DUAL POWER SUPPLY KIT + OPTIONAL	34
OPTIONAL ACCESSORIES: A381 - DRAIN PUMP	35
OPTIONAL ACCESSORIES: P084 – AIR FILTER EPM ₁₀ 50%	35
OPTIONAL ACCESSORIES: A531 – ON-OFF DAMPER	36
OPTIONAL ACCESSORIES: P011 - EMPTY PLENUM	38
OPTIONAL ACCESSORIES: P012 - EMPTY PLENUM CL.A1	38
OPTIONAL ACCESSORIES: P031 - EMPTY INTAKE PLENUM	38
OPTIONAL ACCESSORIES: P032 - EMPTY INTAKE PLENUM CL.A1	38
OPTIONAL ACCESSORIES: P013 - PLENUM + 3 GRILLES	38
OPTIONAL ACCESSORIES: P014 - PLENUM + 3 GRILLES CL.A1	38
OPTIONAL ACCESSORIES: P015 - SILENCED PLENUM	38
OPTIONAL ACCESSORIES: P016 - SILENCED PLENUM + 1 GRILLE	38
OPTIONAL ACCESSORIES: P017 - PLENUM + FILTER EPM2.5 50%	38
OPTIONAL ACCESSORIES: P018 - PLENUM + FILTER EPM1 50%	38
OPTIONAL ACCESSORIES: P019 - PLENUM + FILTER EPM1 85%	38
OPTIONAL ACCESSORIES: P034 – INTAKE FREE-COOLING PLENUM	43
OPTIONAL ACCESSORIES: P041 – SUPPORT FRAME H 255-350MM	47
OPTIONAL ACCESSORIES: P042 – SUPPORT FRAME H 355-450MM	47
OPTIONAL ACCESSORIES: P043 – SUPPORT FRAME H 400-510MM	47
OPTIONAL ACCESSORIES: A272 – CL.0 OR A1 (EN13501-1) INSULATION	48
OPTIONAL ACCESSORIES: P151 – LOWERED DISPLAY FOR UNDER	48
MACHINE DRAWINGS	49
HOLE IN THE RAISED FLOOR FOR DOWNFLOW VERSION	64
EXAMPLE FOR MACHINES NOISE EMISSION CALCULATION	65
VALVE PRESSURE DROP CALCULATION AS FUNCTION OF WATER FLOW RATE	67
AIR FILTERS REPLACEMENT FOR UNDER VERSION MACHINES	68
SHIPMENT: PACKING DIMENSIONS	69
SHIPMENT: SHIPPING WEIGHT	69
SHIPMENT: OPTIONALS PACKING DIMENSIONS AND SHIPPING WEIGHT	70

Liability disclaimer

The present publication is drawn up by of information only and does not constitute an offer binding upon Mitsubishi Electric Hydronics & IT Cooling Systems S.p.A. Mitsubishi Electric Hydronics & IT Cooling Systems S.p.A. has compiled the content of this publication to the best of its knowledge. The data contained herein are subject to change without notice. Mitsubishi Electric Hydronics & IT Cooling Systems S.p.A. explicitly rejects any liability for any direct or indirect damage, in the broadest sense, arising from or related to the use and/or interpretation of this publication. All content is copyrighted by Mitsubishi Electric Hydronics & IT Cooling Systems S.p.A.

CERTIFICATIONS



ISO 9001 CERTIFICATION
Quality Management System



ISO 14001 CERTIFICATION
Environmental Management System



BS OHSAS 18001 CERTIFICATION
Occupational Health and Safety Management System



CE MARKING



CCC – CQC CERTIFICATION
(People's Republic of China)



EAC CERTIFICATION
(Russian Federation, Belarus, Kazakhstan)

GENERAL CHARACTERISTICS



UNDER
Downflow air delivery



OVER
Upflow air delivery

Air conditioners for IT Cooling with variable air flow, for chilled water feeding.

This series is offered in 9 models, available in the following versions:

- Air intake from the front through honeycomb grille and air delivery from the top of the unit (Over).
- Air intake from the top and air delivery from the bottom of the unit (Under).

Cooling capacity: 45 ÷ 234 kW

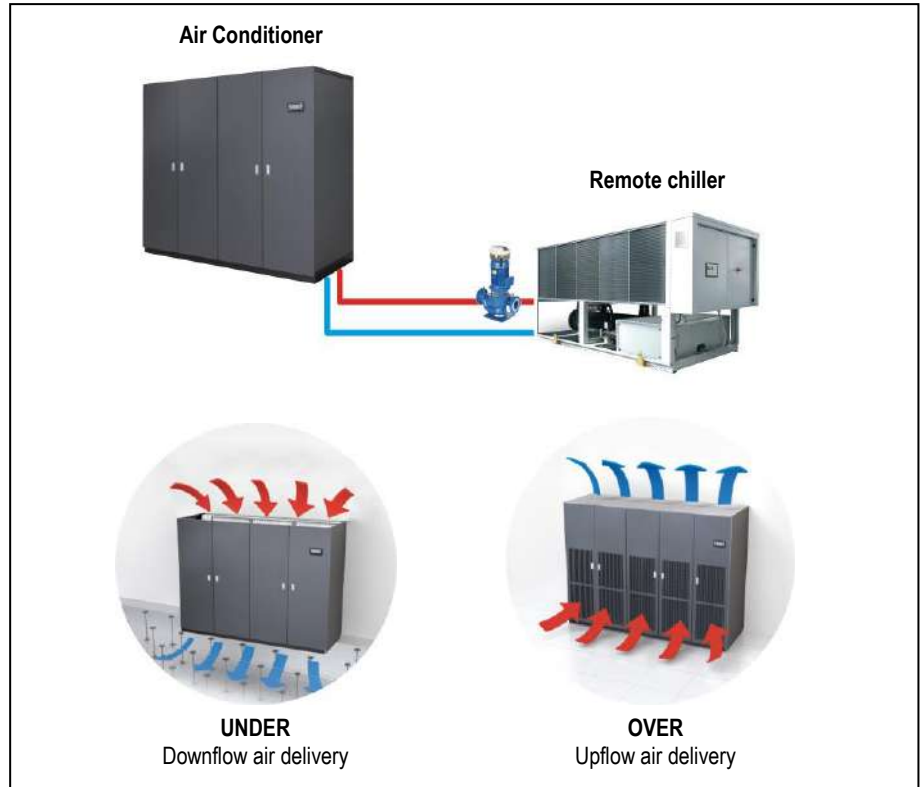

The machines are made for indoor installation.

The constructive solutions and the internal lay-out allow high application flexibility and the frontal access to the main components for the inspection and routine maintenance.

The installation requires electrical and hydraulic connections.

Final assembly on all machines before shipment including running test, reading and monitoring of operating parameters, alarms simulation and visual check.

PRODUCT FEATURES AND BENEFITS

- Wider range and performance increasing
- SHR ratio compared to the previous series, up to 0,95.
- Optimization of the hydraulic circuit.
- New plug fans with EC electric motors with impeller in composite material, which guarantees a reduction of power consumption.
- New fans electric motor that do not require maintenance.
- Improvement of the control software with advanced control logic.
- Increased cooling density, up to 65,2 kW per m².
- Total front access for the routine maintenance.
- Panels fully removable to facilitate the operations of extraordinary maintenance.

INSTALLATION

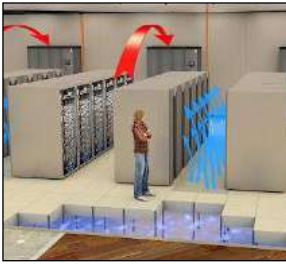

DOWNFLOW VERSION (Under)

Typical installation is on the perimeter.

The units are placed along the perimeter of the data center. Air suction from the top of the unit and air delivery in the underfloor void.

The air distribution is achieved by special tiles placed in front of the racks row, forming cold aisle for air diffusion. On the rear of the racks is expelled the hot air (hot aisle) then aspirated by the unit.

For an optimal installation is advisable to provide the cold aisle containment.

Some solutions provide a service corridor around the server rooms where to place the units. In this case it is necessary to provide the air intake plenum for each unit. With this solution all the space in the Data Center is available for the installation of racks.



UPFLOW VERSION (Over)

The type of installation is practically similar to the previous. The only difference is that for the air distribution in the Data Center is not used the raised floor but ducts in the ceiling.

OPTIONAL

An extensive list of accessories allows the unit to adapt effectively to the real needs of the system, reducing the time and cost of installation.

MODEL IDENTIFICATION

Air conditioners for IT Cooling for chilled water feeding

model: w-AV S O 072 E5

w-AV S

Series

O

Air delivery

O = over – upflow air delivery

U = under – downflow air delivery

072

Model / Cooling capacity (kW) at nominal conditions

E5

Size

THE RANGE

UNDER

E3P

E4

E5

E6

E7

E8

E9

E10



OVER

E3P

E4

E5

E6

E7

E8

E9



TRANSPORT AND STORAGE TEMPERATURE

During transport and if the machine is not installed at the reception, do not remove the packaging and place the machine in an enclosed, dry and protected from sunlight site at temperatures ranging between -30°C and 50°C in absence of superficial condensation.

WORKING LIMITS

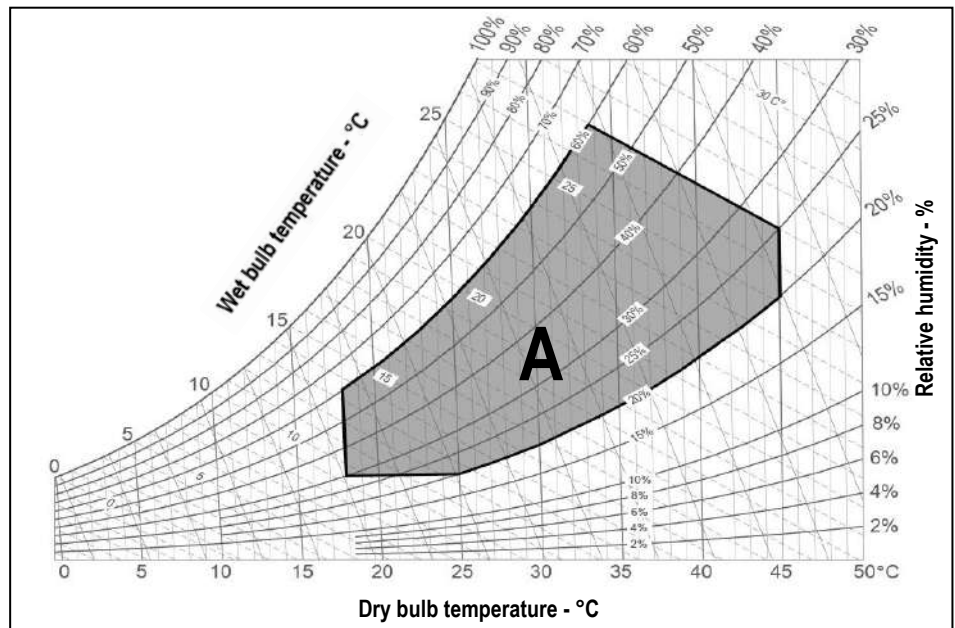

ROOM AIR CONDITIONS

Room air temperature:

- 10°C minimum temperature with wet bulb.
- 27°C maximum temperature with wet bulb.
- 18°C minimum temperature with dry bulb.
- 45°C maximum temperature with dry bulb.

AREA "A". Machine operating envelope.

Room air humidity:

- 20%RH minimum relative humidity.
- 60%RH maximum relative humidity.

CHILLED WATER TEMPERATURE

- 6°C Minimum chilled water inlet temperature
- 25°C Maximum chilled water inlet temperature
- ΔT 3°C Minimum temperature difference between chilled water inlet and outlet
- ΔT 10°C Maximum temperature difference between chilled water inlet and outlet

HYDRAULIC CIRCUIT

- ΔP 5-150kPa Pressure drop range of the hydraulic circuit.
- 10 Bar Maximum working pressure of the hydraulic circuit

POWER SUPPLY

- ± 10% Maximum tolerance of the supply voltage (V)
- ± 2% Maximum unbalancing of the phases.

LIMIT OF CHILLED WATER TEMPERATURE AT THE UNIT'S INLET

The table shows the recommended minimum water temperature at the unit's inlet (°C), at different ambient air conditions.

Lower chilled water temperatures may cause water droplets in the air flow or condensate drain problem.

		Room Air Temperature					
		18°C	25°C	30°C	35°C	40°C	45°C
Relative Humidity	60%	6,0	10,4	16,4	--	--	--
	50%	6,0	8,2	13,9	19,5	--	--
	40%	6,0	6,0	11,2	16,5	--	--
	30%	6,0	6,0	7,0	12,1	16,2	--
	25%	--	6,0	6,0	8,9	13,2	--
	20%	--	6,0	6,0	6,0	9,7	13,8

MAIN COMPONENTS

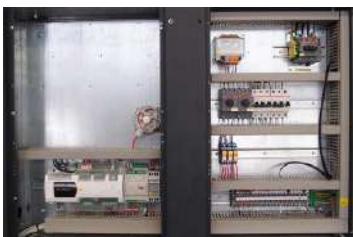

FRAMEWORK

- Base in aluminium extrusion, painted with epoxy powders. Colour RAL 9005.
- Frame in aluminium profile, painted with epoxy powders. The inner frame is provided with seals for the panels. Colour RAL 9005.
- Panels in galvanized steel sheet with protective surfaces treatment in compliance with UNI ISO 9227/ASTMB117 and ISO 7253, and painted with epoxy powders. Colour RAL 7016 hammered.
- Panels insulated with polyurethane foam and seals to ensure airtight.
- Hinged front panels with quick release removal system.
- Total front access for routine maintenance.
- Removable lateral and back side panels.
- Compartment for electrical panel on unit front for direct access to control and regulation devices.

FILTER SECTION

- Washable air filters with COARSE 60% efficiency (according to ISO EN 16890), with cells in synthetic fibre and metallic frame.
- Air filters access:
OVER version: Frontal access for all machines
UNDER version: Access from upper side

COOLING SECTION

- Heat exchanger coil with internally corrugated copper tubes and high efficiency aluminium fins, specifically developed to provide high heat transfer and lower pressure drops.
- Finned pack with hydrophilic treatment that assure the condensate water drop, high thermal conductivity and does not favour the growth of micro-organisms.
- 2-way motorized valve for water flow regulation with 0÷10 VDC control actuator and emergency manual control.
- Frame in galvanized steel.
- Condensate tray in peraluman with PVC flexible discharge pipe.
- Temperature sensor on air intake with function of temperature display.
- Temperature sensor on air delivery with function of control and regulation.
- Temperature probe on chilled water inlet.

FANS SECTION

The fan section is contained within the machine and includes:

- Centrifugal fans with backward curved blades with wing profile, single suction and without scroll housings (Plug-fans), directly coupled to external rotor electric motor.
 - Impeller in composite material exempt from rust formation.
 - Brushless type synchronous EC motor with integrated electronic commutated system and continuous variation of the rotation speed. The motor rotation control is obtained with the EC system (Electronic Commutation) that manage the motor according to the signal coming from the microprocessor control.
- Fans control through ModBus. In case of failure, the control stops the interested fan indicating the type of fault. The machine with more than one fan is not stopped.
- Adjustable External Static Pressure (ESP).
- Fan guard with rubber support (UNDER version)

ELECTRICAL PANEL

In accordance with EN60204-1 norms, suitable for indoor installation, complete with:

- Main switch with door lock safety on frontal panel.
- Magnetothermic switch for supply fans.
- Transformer for auxiliary circuit and microprocessor supply.
- Numbered wirings.
- OUTLETS Terminals:
 - Voltage free deviating contact for General Alarm 1-2.
 - Voltage free contact for supply fans status.
 - Voltage free contact for smoke / fire sensor (the sensors are accessory)
- INLETS Terminals:
 - External enabling.
- Power supply 400/3+N/50.



CONTROL SYSTEM

Microprocessor control system with graphic display for control and monitor of operating and alarms status.

The system includes:

- Built-in clock for alarms date and time displaying and storing.
- Built-in memory for the storing of the intervened events (up to 200 events recorded).
- Predisposition for additional connectivity board housing (MODBUS, LON, BACNET MS/TP RS485, BACNET OVER IP). The electronic cards are optional accessories.
- Main components hour-meter.
- Non-volatile "Flash" memory for data storage in case of power supply faulty.
- Menu with protection password.
- LAN connection (max 15 units).

OPTIONAL ACCESSORIES

The descriptions of these additional components can be found in Chapter OPTIONAL ACCESSORIES.

P121.....	Front air intake + bottom panel. Unit base noise insulation with special bottom panel for OVER version. Restriction: Non-compatible with "P122 Bottom air intake + blind panels" for OVER version.
P122.....	Bottom air intake + blind panels. Blind frontal panel for OVER version. The accessory allows the intake air from the bottom of the machine. Restriction: Not compatible with "P121 Front air intake + bottom panel" for OVER version.
A548.....	Constant prevalence. Automatic system for the air pressure control in the underfloor (Under version) or in the duct (Over version). The system controls the supply fans rotation speed in order to keep constant the air pressure via a differential pressure transmitter connected to the microprocessor control.
P091.....	Back-up module controller. The system guarantees the microprocessor power supply for a few minutes, in case of supply voltage failure.
383.....	Numbered wirings + UK requests.
4181 / 4182 / 4184 / 4185...	Serial cards: 4181 – Serial card MODBUS. 4182 – Serial card LON. 4184 – Serial card BACNET MS/TP RS485. 4185 – Serial card BACNET OVER IP.
A491.....	Water leakage detector. Supplied in mounting kit.
A492.....	Water leakage detector + additional sensor. Supplied in mounting kit.
A501.....	Clogged filter sensor. Differential pressure switch on the air side for clogged filters alarm signal.
A511.....	Smoke detector. Supplied in mounting kit.
A521.....	Fire detector. Supplied in mounting kit.
A822.....	ADAPTIVE SET POINT: function that optimizes the operation of liquid chillers connected to the indoor air conditioners by control of the effective room thermal load.
5891.....	Control unit via kiplink.
6461.....	HPC.
A35B.....	Graphic display "Evolution Touch"
A352.....	No Display
P141.....	Analogue set-point compensation. Analogue set point compensation according to an external analogue signal at Customer care.
A842.....	Network analyser. Multifunction utility for calculating and displaying the machine electrical measurements.
A812 (1).....	Free-cooling direct control.
P021.....	2-way ball by-pass valve. 2-way modulating motorized valve with 0÷10 VDC control actuator and emergency manual control for the third way (by-pass) of the chilled water hydraulic circuit. The valve is in combination with the main water flow control valve.
P131.....	Hot water coil + 2-way valve. Hot water heating system (size E10 excluded).
A431.....	Electric heater. Heating with electric heaters.
A432.....	Extra power electric heater.
4301 / 4303 / 4305 (2).....	Humidification: Modulating steam humidifier with immersed electrodes with electronic control. 4301 - Steam humidifier 3kg/h 4303 - Steam humidifier 8kg/h 4305 - Steam humidifier 15kg/h
P051 (3).....	Dehumidification function.
A791.....	Air temperature control on suction air.
P161.....	T/rH air intake sensor. Combined Temperature / Humidity sensor on air intake. The optional replace the standard temperature sensor on machine air intake.
4666.....	External air probe. External air temperature probe.

P071/P072/P073/P074	Remote T/rH probe. Combined Temperature / Humidity sensor for remote installation. The optional is added to the standard temperature sensor on machine air intake.
P111 / P112 / P113 / P114 .	Dual power supply. Dual power supply with automatic change-over. P111 - Dual power supply. P112 - Dual power supply + optional. P113 - Dual power supply kit. P114 - Dual power supply kit + optional.
A381.....	Drain pump. Supplied in mounting kit. The system includes pump with activation float and 10 linear meters long discharge pipe.
P084.....	Air filter ePM₁₀ 50%. Washable high efficiency air filter (according to ISO EN 16890). Not compatible with "P017 / P018 / P019 Plenum + filter ePM _{2,5} 50%, ePM ₁ 50%, ePM ₁ 85% (according to ISO EN 16890)".
A531 (4)	On-off damper. Non-return air damper with frame driven by electric servomotor installed on the machine air delivery.
P011.....	Empty plenum.
P012.....	Empty plenum CL.A1. Plenum with fire reaction in class "0" or "A1".
P013.....	Plenum + 3 grilles on three sides with double adjustable row.
P014.....	Plenum + 3 grilles CL.A1. Plenum with grilles on three sides with double adjustable row, with fire reaction in class "0" or "A1".
P015.....	Silenced plenum. Not compatible with "P084 Air filter ePM ₁₀ 50%".
P016.....	Silenced plenum + 1 grille. Grille with double adjustable row on front side and sound absorbers.
P017.....	Plenum + filter ePM_{2,5} 50%. Plenum with high efficiency air filter (according to ISO EN 16890). Not compatible with "P084 Air filter ePM ₁₀ 50%".
P018.....	Plenum + filter ePM₁ 50%. Plenum with high efficiency air filter (according to ISO EN 16890). Not compatible with "P084 Air filter ePM ₁₀ 50%".
P019.....	Plenum + filter ePM₁ 85%. Plenum with high efficiency air filter (according to ISO EN 16890). Not compatible with "P084 Air filter ePM ₁₀ 50%".
P031 (5)	Empty intake plenum.
P032 (5)	Empty intake plenum CL.A1. Plenum with fire reaction in class "0" or "A1".
P034 (6)	Intake free-cooling plenum.
P041 / P042 / P043.....	Support frame with height adjusting rubber holders. Supplied in mounting kit. It is not possible to match the support frame with plenum installed under the machine. P041 – Support frame h 255-350mm P042 – Support frame h 355-450mm P043 – Support frame h 400-510mm
A272.....	CL. 0 or A1 (EN 13501-1) insulation: Panelling with fire reaction in class "0" or "A1".
P151.....	Lowered display for Under – for UNDER units equipped with plenum under the unit.
9973	Wooden cage packing. The machines are delivered on wooden pallet, covered with shrink wrap and packaged in wooden cage.
B912.....	Remote keyboard K200. Graphic display for remote installation, the optional is added to the standard graphic display placed on machine frontal panel.

WARNING

The Manufacturers reserves the right to accept the matching of the optional installed on the machine.

MANDATORY COMBINATIONS OF ACCESSORIES

1. When optional accessory "A812 Free cooling direct control" is present, it requires mandatory accessories "P161 T/rH air intake sensor" and "4666 External air probe".
2. When optional accessories "4301 / 4303 / 4305 Steam humidifier" are present, they require mandatory accessory "P161 T/rH air intake sensor".
3. When optional accessory "P051 Dehumidification function" is present, it requires mandatory accessory "P161 T/rH air intake sensor".
4. When optional accessory "A531 On-off damper" is present, it requires mandatory accessory "9973 Wooden cage packing".
5. When optional accessories "P031 Empty intake plenum, for OVER version" and "P032 Empty intake plenum CL.A1, for OVER version" are present, they require mandatory accessory "P122 Bottom air intake+blind panels, for OVER version only".
6. When optional accessory "P034 Intake free-cooling plenum" is present, it requires mandatory accessories "P161 T/rH air intake sensor", "4666 External air probe", "A812 Free-cooling direct control" and "P122 Bottom air intake+blind panels, for OVER version only".
7. When accessory A352 "NO DISPLAY" is present, it requires mandatory accessory 5891 "Unit control via Kiplink".
8. When accessory 6461 "HPC" is present, it requires mandatory accessory 5891 "Unit control via Kiplink".

TECHNICAL DATA

VERSION (1)		U / O	U / O	U / O	U / O	U / O	U / O	U / O
MODEL		045	053	072	081	100	120	138
SIZE		E3P	E4	E5	E6	E7	E8	E9
COOLING CAPACITY (2)								
Total	kW	45,5	53,5	78,8	81,7	101	128	140
Sensible	kW	42,1	49,8	67,7	76,1	94	114	130
SHR (3)		0,93	0,93	0,86	0,93	0,93	0,89	0,93
"EC" SUPPLY FANS	n.	1	1	2	2	2	3	3
Air flow	m ³ /h	10800	13100	16350	20000	24200	28300	33100
Nominal external static pressure	Pa	20	20	20	20	20	20	20
Maximum external static pressure	Pa	492	203	857	655	250	601	497
Fans power input (4)	kW	2,20	2,15	2,90	3,47	3,98	6,22	6,42
COOLING COIL								
Water flow rate (2)	m ³ /h	7,83	9,20	13,6	14,1	17,4	22,0	24,1
dP coil + valve (2)	kPa	41,5	45,6	59,6	43,4	38,1	62,6	56,9
Water volume	l	11,4	13,8	18,1	21,2	24,6	28,5	33,8
AIR FILTERS	n.	2	3	3	4	4	5	6
Filter area	m ²	1,71	2,07	2,59	3,16	3,83	4,47	5,24
Efficiency (ISO EN 16890)	COARSE	60%	60%	60%	60%	60%	60%	60%
POWER SUPPLY	V/Ph/Hz	400/3+N/50	400/3+N/50	400/3+N/50	400/3+N/50	400/3+N/50	400/3+N/50	400/3+N/50
ENERGY EFFICIENCY INDEX (2)								
EER Energy Efficiency Ratio	kW/kW	20,7	24,9	27,2	23,5	25,4	20,6	21,8
DIMENSIONS								
Length	mm	1085	1305	1630	1875	2175	2499	2899
Width	mm	930	930	930	930	930	930	930
Height	mm	1925	1980	1980	1980	1980	1980	1980
NET WEIGHT OVER	kg	321	345	428	483	535	598	679
NET WEIGHT UNDER	kg	329	379	470	531	589	660	753
HYDRAULIC CONNECTIONS								
WATER INLET / OUTLET ISO 7/1 - R	Ø	1+1/4"	1+1/2"	2"	2"	2+1/2"	2+1/2"	3"
CONDENSATE DISCHARGE								
Rubber pipe – internal diameter	Ø mm	19	19	19	19	19	19	19

THE COOLING CAPACITY DOES NOT CONSIDER THE SUPPLY FAN MOTOR THERMAL LOAD

1. U = Under, downflow / O = Over, upflow
2. Gross value. Characteristics referred to entering air at 24°C-50%RH with chilled water temperature 7-12°C - 0% glycol. ESP=20Pa.
3. SHR = Sensible cooling capacity / Total cooling capacity.
4. Corresponding to the nominal external static pressure.

TECHNICAL DATA

VERSION (1)		U	U
MODEL		160	215
SIZE		E10	E10
COOLING CAPACITY (2)			
Total	kW	171	234
Sensible	kW	151	177
SHR (3)		0,88	0,76
"EC" SUPPLY FANS	n.	3	3
Air flow	m ³ /h	37150	37150
Nominal external static pressure	Pa	20	20
Maximum external static pressure	Pa	214	207
Fans power input (4)	kW	6,44	6,44
COOLING COIL			
Water flow rate (2)	m ³ /h	29,5	40,3
dP coil + valve (2)	kPa	89,1	79,7
Water volume	l	44	66
AIR FILTERS	n.	6	6
Filter area	m ²	6,54	6,54
Efficiency (ISO EN 16890)	COARSE	60%	60%
POWER SUPPLY	V/Ph/Hz	400/3+N/50	400/3+N/50
ENERGY EFFICIENCY INDEX (2)			
EER Energy Efficiency Ratio	kW/kW	26,6	36,3
DIMENSIONS			
Length	mm	3510	3510
Width	mm	930	930
Height	mm	1980	1980
NET WEIGHT OVER	kg	-	-
NET WEIGHT UNDER	kg	900	970
HYDRAULIC CONNECTIONS			
Water Inlet / Outlet – DN / Inch (5)	Ø	80 / 3"	80 / 3"
CONDENSATE DISCHARGE			
Rubber pipe – internal diameter	Ø mm	19	19

THE COOLING CAPACITY DOES NOT CONSIDER THE SUPPLY FAN MOTOR THERMAL LOAD

1. U = Under, downflow / O = Over, upflow
2. Gross value. Characteristics referred to entering air at 24°C-50%RH with chilled water temperature 7-12°C - 0% glycol. ESP=20Pa.
3. SHR = Sensible cooling capacity / Total cooling capacity.
4. Corresponding to the nominal external static pressure.
5. Grooved connection. The grooved flexible joint is not supplied

HYDRAULIC DIAGRAM

Below hydraulic diagram referred to the standard configuration without optional.

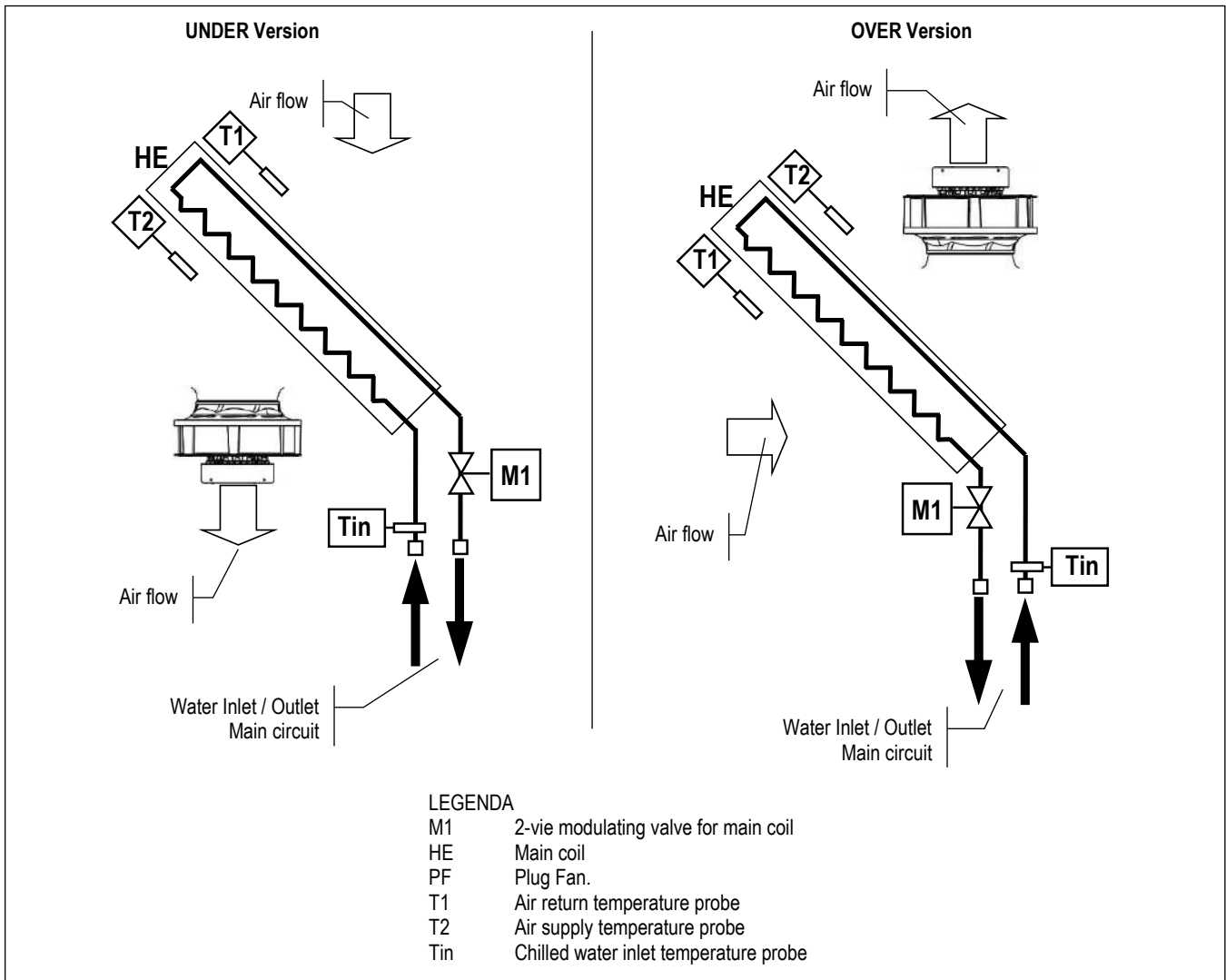

2-WAY BALL VALVE FOR CHILLED WATER FLOW CONTROL



The water flow control in the finned coil is achieved through a **2-way modulating ball valve with equal percentage flow control** ensured by the integrated characterizing disc.

This type of valve offers the following series of benefits:

- Equal percentage flow control.
- No peaks initial flow.
- Excellent stability control thanks to the integrated characterizing disc.
- Excellent characteristic in partialisation.
- Stability in control.
- Maintenance free.
- Self-cleaning.

CHARACTERISTICS OF THE 2-WAY BALL VALVE

- Closing seal with leakage rate in Class A (EN 12266-1)
- Maximum fluid pressure $P_s=1600\text{kPa}$
- Maximum closing pressure (Close-off) $\Delta P_s=1400\text{kPa}$

The rotative actuator is controlled by a signal 0 ... 10VDC from the microprocessor controller. The actuator is equipped with an emergency button for manual operation and is maintenance-free.

ACOUSTIC DATA

Acoustic data of the standard machine at full load working conditions.

WARNING:

In a closed room the noise produced by a sound source reaches the listener in two different ways:

- Directly
- Reflected from the surrounding walls, floor, ceiling, from furniture.

With the same sound source, the noise produced in a closed room is greater than that produced outdoors. In fact, the sound pressure level generated by the source, must be added to the one reflected from the room. Also, the shape of the room affects the sound.

VERSION (1)		U / O	U / O	U / O	U / O	U / O	U / O	U	U	
MODEL		045	053	072	081	100	120	138	160	215
SIZE		E3P	E4	E5	E6	E7	E8	E9	E10	E10
SOUND LEVEL (2)										
On air delivery Under	dB(A)	78,8	79,1	79,7	80,2	80,7	84,5	84,1	83,0	83,0
On air intake Under	dB(A)	66,2	66,5	65,5	67,5	68,0	70,4	71,5	70,3	70,3
On front side Under	dB(A)	57	57	56	58	59	61	62	61	61
On air delivery Over	dB(A)	78,8	79,1	79,7	80,2	80,7	84,5	80,7	--	--
On air intake Over (3)	dB(A)	61	61	60	62	63	65	63	--	--
On front side Over (4)	dB(A)	56,7	57,1	55,9	58,1	58,6	60,8	58,6	--	--

1. U = Under, downflow / O = Over, upflow
2. Noise pressure level at 1 meter in free field – ISO 3744
3. Air intake from the front
4. Air intake from the bottom

ELECTRICAL DATA

VERSION (1)		U / O	U / O	U / O	U / O	U / O
MODEL		045	053	072	081	100
SIZE		E3P	E4	E5	E6	E7
Power supply	V/Ph/Hz	400/3+N/50	400/3+N/50	400/3+N/50	400/3+N/50	400/3+N/50
Maximum current input (FLA)	A	5,40	4,10	11,2	10,8	8,20

VERSION (1)		U / O	U / O	U	U
MODEL		120	138	160	215
SIZE		E8	E9	E10	E10
Power supply	V/Ph/Hz	400/3+N/50	400/3+N/50	400/3+N/50	400/3+N/50
Maximum current input (FLA)	A	16,8	16,2	12,3	12,3

1. U = Under, downflow / O = Over, upflow

WARNING:

The electric data indicated refer only to the indoor unit.

Optional accessory electric data are included within the dedicated chapters and must be added.

Please refer to ELCA WORLD selection program to calculate the electrical data of the air conditioner according to the requested optional accessories.

WATER QUALITY OF THE HYDRAULIC CIRCUITS

The values shown in the table must be guaranteed during the entire life cycle of the machine.

	Description	Symbol	Range
1	Hydrogen Ions	pH	7.5 ÷ 9
2	Presence of calcium (Ca) and magnesium (Mg)	Hardness	4 ÷ 8.5 °D
3	Chlorine ions	Cl ⁻	< 150 ppm
4	Iron Ions	Fe ³⁺	< 0.5 ppm
5	Manganese Ions	Mn ²⁺	< 0.05 ppm
6	Carbon dioxide	CO ₂	< 10 ppm
7	Hydrogen sulphide	H ₂ S	< 50 ppb
8	Oxygen	O ₂	< 0.1 ppm
9	Chlorine	Cl ₂	< 0.5 ppm
10	Ammonia	NH ₃	< 0.5 ppm
11	Ratio between carbonates and sulphates	HCO ₃ ⁻ /SO ₄ ²⁻	> 1
12	Sulphate ions	SO ₄ ⁻	< 100 ppm
13	Phosphate ions	PO ₄ ³⁻	< 2.0 ppm

where: $1/1.78^{\circ}D = 1^{\circ}Fr$ with $1^{\circ}Fr = 10 \text{ gr CaCO}_3 / \text{m}^3$

ppm = parts for millions

ppb = part for billion

Explanatory notes:

- ref.1: A greater concentration of hydrogen ions (pH) than 9 implies a high risk of deposits, whereas a lower pH than 7 implies a high risk of corrosion.
- ref.2: The hardness measures the amount of Ca and Mg carbonate dissolved in the water with a temperature lower than 100°C (temporary hardness). A high hardness implies a high risk of deposits.
- ref.3: The concentration of chloride ions with higher values than those indicated causes corrosion.
- ref. 4 - 5 - 8: The presence of iron and manganese ions and oxygen leads to corrosion.
- ref.6 - 7: Carbon dioxide and hydrogen sulphide are impurities that promote corrosion.
- ref.9: Usually in water from the waterworks it is a value of between 0.2 and 0.3 ppm. High values cause corrosion.
- ref.10: The presence of ammonia reinforces the oxidising power of oxygen
- ref.11: Below the value shown in the table, there is a risk of corrosion due to the trigger of galvanic currents between copper and other less noble metals.
- ref.12: The presence of sulphates ions triggers corrosion phenomenon.
- ref.13: The presence of phosphates ions triggers corrosion phenomenon.

It is necessary to carry out periodic checks, with withdrawals at different points of the hydraulic system. During the first year of operation, checks are recommended every 4 months which can be reduced every 6 months starting from the second year of operation.

WARNING:

Values of the parameters outside the indicated ranges can lead to the formation of deposits and limescale and/or favour corrosive phenomena within the plant. For operating fluids other than water (mixtures of ethylene and propylene glycol) it is recommended to use specific inhibitors, designed to offer thermal stability within the operating temperature range and protection against corrosion. It is necessary that, in the presence of dirty and / or aggressive waters, an intermediate heat exchanger is installed upstream of the heat exchangers.

ANTIFREEZE MIXTURES

In plants that are not adequately protected by heating cables, protect the hydraulic circuit with an anti-freeze mixture when the ambient air temperature can drop below 5°C.

Minimum ambient air temperature	°C	5	0	-5	-10	-15	-20	-25	-30
ETHYLENE GLYCOL (suggested % in weight)	%	0	12	20	30	35	40	45	50

Minimum ambient air temperature	°C	5	2	-3	-9	-13	-17	-23	-29
PROPYLENE GLYCOL (suggested % in weight)	%	0	10	20	30	35	40	45	50

The values are indicative and may significantly vary depending on the glycol manufacturer. Refer to your glycol supplier for detail.

The values consider a precautionary difference of 5°C between the minimum ambient air temperature and the freezing temperature of the mixture.

In the hydraulic circuit do not send fluids other than water or mixtures with ethylene / propylene glycol.

If other products are provided, in addition to mixtures of water and ethylene or propylene glycol, contact the Manufacturer to check the compatibility with the machine components.

MICROPROCESSOR CONTROL SYSTEM



Controller



Keyboard and Display

The unit is equipped with the controller connected to a 6 keys keyboard with graphic display on which all information in English language or easily identifiable symbols are displayed. The controller disposes of a “flash” memory that preserves the information even in absence of power supply. Part of memory is dedicated to the registration of intervened events - up to 200 events. The system can manage up to 4 T/H probes on air intake, 4 T/H probes on air delivery, 4 remote T/H probes and a T/H probe for outdoor air.

DISPLAY – KEYBOARD FUNCTIONS

	ALARM	Alarm presence with red light. Push for alarm description. In case of more alarms scroll by UP / DOWN.
	PRG	Menu list, scrolled by UP/DOWN: Unit; Set-point; In/Out; Clock; History; User; Service; Factory. ENTER to execute.
	ESC	Home. Used to come back to the previous menu level or to the main screen.
	UP DOWN	Changes pages and values of sets. By pressing in HOME mask, the synoptic of the main controls is displayed.
	ENTER	Moving the cursor on adjustable Program(s) fields to confirm the changes. Press ENTER to get out the fields.

DISPLAY - MAIN MASK

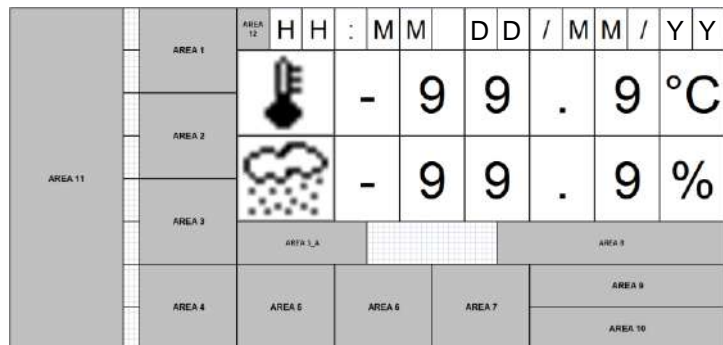

The main mask shows time, date, room temperature and humidity values (if the relative probe is present) and areas for displaying operating and alarm status with dedicated icons:

- Area 1: Status of the unit: on / off
- Area 2: Status detail
- Area 3: Type of event (only in case of an event)
- Area 3_A: Code and type of event
- Area 4: Active cooling devices
- Area 5: Active free-cooling devices
- Area 6: Active humidity devices
- Area 7: Active heating devices
- Area 8: on / off parameters
- Area 9: BMS address
- Area 10: LAN address
- Area 11: Schematic representation of units
- Area 12: Active function presence icon

CONNECTIVITY

Through the optional serial port, the microprocessor control enables communication with the modern buildings BMS systems with the following protocols: MODBUS; LON; BACNET MS/TP RS485; BACNET OVER IP.

PASSWORD

- Level 1: On request of the End User. Allowing to reach USER menu
- Level 2: Asks to Service: Allowing to reach SERVICE menu
- Level 3: Asks to Service: Allowing to reach FACTORY menu
- No passwords request to enter: UNIT, SETPOINT, IN/OUT, CLOCK, HISTORY menu



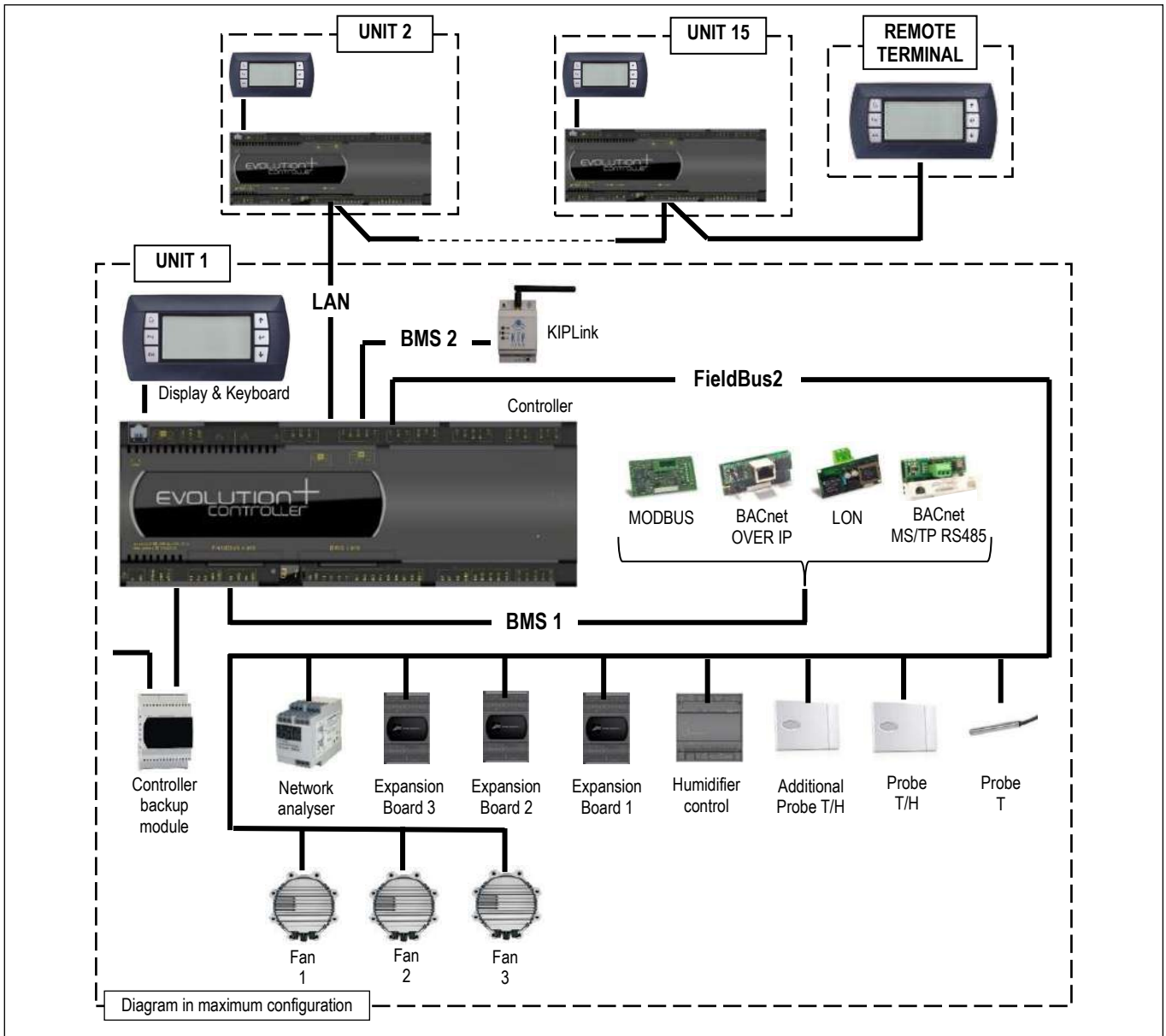

LAN NETWORK

The LAN is part of the control software and it is possible to connect up to 15 units. This type of connection allows to control the units in coherent way, moreover the units can be controlled and managed from a shared remote terminal.

LAN ADDRESS LIST

Units n.	1	2	3	4	5	6	7	8	9	10	11	12	13	14	15	Remote terminal
Controller address	1	2	3	4	5	6	7	8	9	10	11	12	13	14	15	---
Display & Keyboard address	16	17	18	19	20	21	22	23	24	25	26	27	28	29	30	32

The unit connection to the local network (LAN) allows to perform the following functions:

- Balancing the operating hours among the different units by rotating the reserve units.
- Turning on the reserve units in case other units should turn off due to an alarm, maintenance or power feed interruption.
- Turning on reserve units to offset the excessive thermal load.
- Operating with all units based on the average temperature and humidity values read by the temperature probes only in the operating units.
- DYNAMIC MASTER function that makes the role of the Master unit dynamic. In case of alarm, shutdown, maintenance, power failure, etc. on the Master unit, the function automatically elects a new Master unit.

ACTIVE REDUNDANCY



Chilled water units, thanks to its electronically commutated EC fans, 2-way motorized valves for chilled water flow control and an advanced algorithm to balance the heat loads among the units (including the units in stand-by), achieve an ACTIVE REDUNDANCY combining reliability, efficiency and reduced Total Cost of Ownership.

PASSIVE REDUNDANCY

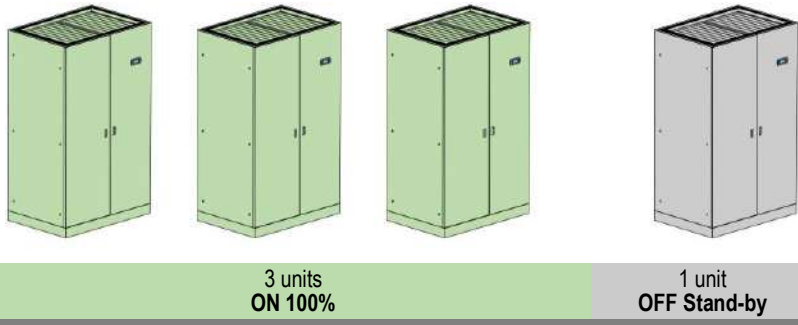

ACTIVE REDUNDANCY

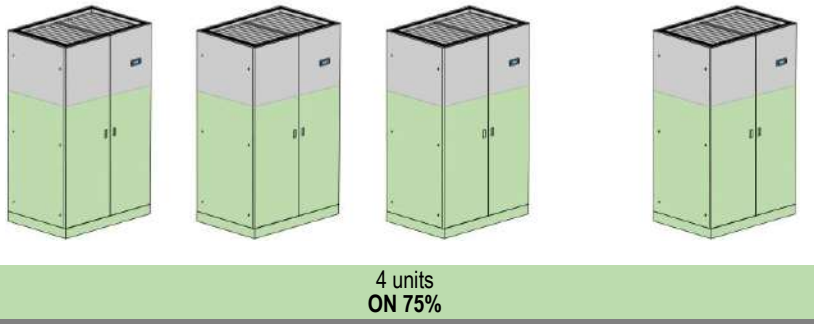

TEMPERATURE PROBE ON AIR SUCTION / DELIVERY

Temperature probe installed on the air suction and delivery of the unit.
Standard temperature control and regulation are on air delivery.

Is possible to select the optional accessory A791 "Air temperature control on suction air" to realize the temperature control and regulation on suction air.

With following optional accessories temperature control and regulation is exclusively on suction air:

- A431 – Electric heater.
- A432 – Extra power electric heater.
- P131 – Hot water coil+2way valve.

OPTIONAL ACCESSORIES: P121 – FRONT AIR INTAKE+BOTTOM PANEL

Available for OVER units.

The optional is not compatible with "P122 Bottom air intake+blind panels" for OVER units.

With this accessory, it is possible a noise insulation of the machine base, when the machine is installed directly on floor as raised floor, wood floor etc.

The accessory includes:

- Panel in galvanized steel sheet.
- Noise insulation with special soundproof material.

The bottom panel is supplied assembled inside the unit base and does not modify the unit dimensions.

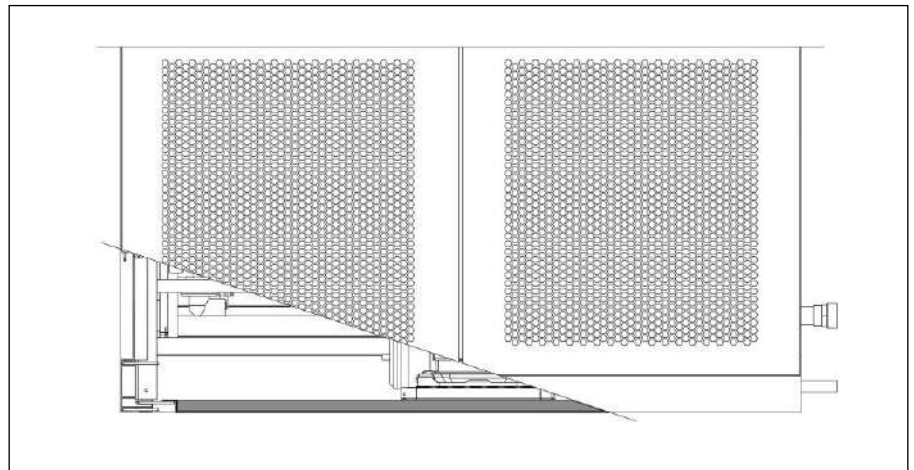
**OPTIONAL ACCESSORIES: P122 - BOTTOM AIR INTAKE+BLIND PANELS**

Available for OVER units.

The optional is not compatible with "P121 Front air intake+bottom panel" for OVER units.

Thanks to the design of the basement is possible the air suction from the unit bottom. The air flow rate is the nominal one

The accessory foresees the blind frontal panels.

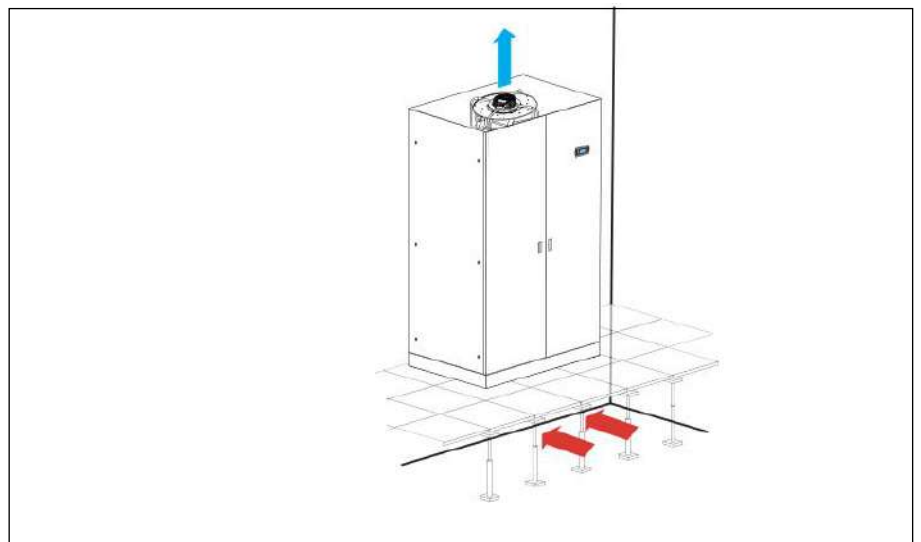

OPTIONAL ACCESSORIES: A548 - CONSTANT PREVALENCE



The optional is a differential pressure sensor with a 0...20mA output signal. The device is installed in the machine.

The sensor is connected to the microprocessor control of the indoor unit and allows the control of:

A548 - CONSTANT PREVALENCE

The system controls the air pressure in the raised floor (Under version) or in the duct (Over version). Through the relief piping of the room pressure (low pressure side) and the air supply of the fan (high pressure side) the fan rotation speed is controlled to keep the air pressure constant. Pressure control range from 0 to 100 Pa.

OPTIONAL ACCESSORIES: P091 – BACK-UP MODULE CONTROLLER



The optional is installed within the electrical panel.

The system powers the microprocessor for a few minutes in the event of a power failure or voltage surges, preventing the re-boot of the controller.

OPTIONAL ACCESSORIES: 383 – NUMBERED WIRINGS + UK REQUESTS

The machine's electrical cables are all numbered for easy identification. For the power section it is possible to change the colour for the UK market.

CABLE	383 – COLOUR FOR UK
EARTH	YELLOW / GREEN
NEUTRAL	BLUE SKY
PHASE 1 (L1)	BROWN
PHASE 2 (L2)	BLACK
PHASE 3 (L3)	GREY
AUXILIARIES	RED

OPTIONAL ACCESSORIES: 4181 – SERIAL CARD MODBUS



The card is factory installed.
Consult the Interface Manual for all technical information.

OPTIONAL ACCESSORIES: 4182 – SERIAL CARD LON



The card is factory installed.
The manufacturer will supply the serial card and .NXE file and a .XIF files necessary for LonWorks technicians to configure the network.
The board is programmed by the technician in charge of the integration.
Consult the Interface Manual for all technical information.

OPTIONAL ACCESSORIES: 4184 – SERIAL CARD BACNET MS/TP RS485



The card is factory installed.
 The supervision network is set up by the technicians developing the BACnet interface.
 The Modbus protocol database is used for interfacing.
 Consult the Interface Manual for all technical information.

OPTIONAL ACCESSORIES: 4185 – SERIAL CARD BACNET OVER IP



The card is factory installed.
 The supervision network is set up by the technicians developing the BACnet interface. The Modbus protocol database is used for interfacing.
 The manufacturer will supply the card and .MIB file necessary for technicians to configure the network.
 The board is programmed by the technician in charge of the integration.
 Consult the Interface Manual for all technical information and what is necessary for Internet connection to view and modify variables.

OPTIONAL ACCESSORIES: A491 – WATER LEACKAGE DETECTOR



The system includes an electronic relay installed in the electrical panel of the machine and a water detector.
 The electrical connections for the probe and the alarm contact are present in the machine's terminal board.
 Sensor is supplied to be connected and installed at customer care.

OPTIONAL ACCESSORIES: A492 – WATER LEACKAGE DETECTOR + ADDITIONAL DETECTOR



The system includes an electronic relay installed in the electrical panel of the indoor machine and 2 water detectors to be connected in series.
 The electrical connections for the probe and the alarm contact are present in the indoor machine's terminal board.
 The sensors are supplied to be connected and installed at customer care.

OPTIONAL ACCESSORIES: A501 - CLOGGED FILTERS SENSOR



The system includes a differential pressure switch installed in the electrical panel or in the front of the indoor unit and the plastic hoses for the relief of the pressure upstream and downstream the air filters.

Control range: 0.3 ... 4.0 mbar (30 ... 400 Pa)
 Differential for intervention: 0.15 mbar (15 Pa)

OPTIONAL ACCESSORIES: A511 – SMOKE DETECTOR
OPTIONAL ACCESSORIES: A521 – FIRE DETECTOR

Is possible to install one or both of the following sensors. Sensors are supplied in mounting kit. Installation within the room at customer care.



A511 - SMOKE DETECTOR

The device is supplied in mounting kit.
 The optical smoke detector senses the presence of combustion by-products (visible smoke) and activates an alarm.
 The operating principle is based on the light scattering technique (Tyndall effect).
 The device is in conformity to EN 54-7 standard.

Technical features:

Material	ABS	Relative humidity	<93% not-condensing
Power supply	12...28 Vdc	Index of protection	IP 20
Normal current	50µA 24 Vdc	Testing by magnet	Yes
Alarm current	25mA 24 Vdc	Relay	max. 1A 30Vdc
LED visibility	360° (double led)	Signal repeater	14mA 24 Vdc
Storage temperature	-10...+70°C	Covered area	40m² max.
Operating temperature	-10...+70°C	Shielded connection	Min. 0.5 mm²
Max. speed air	0.2 m/s	Colour	White

Supplied with unit to be connected and installed at customer care close to the unit.



A521 - FIRE DETECTOR

The device is supplied in mounting kit.
 The fire detector has been designed to identify temperatures at which fires may start. When the temperature exceeds the set threshold or when there is a rapid variation in temperature, the relay is activated to signal an alarm.
 The device is in conformity to EN 54-5 standard.

Technical features:

Material	ABS	Index of protection	IP 20
Power supply	12...28 Vdc	Testing by magnet	Yes
Normal current	50µA 24 Vdc	Relay	max. 1A 30Vdc
Alarm current	25mA 24 Vdc	Signal repeater	14mA - 24 Vdc
LED visibility	360° (double LED)	Alarm temperature	62°C
Storage temperature	-10...+70°C	Covered area	40m² max.
Operating temperature	-10...+70°C	Shielded connection	Min. 0.5 mm²
Relative humidity	<93% non-condensing	Colour	White

Supplied with unit to be connected and installed at customer care close to the unit.

OPTIONAL ACCESSORIES: A822 – ADAPTIVE SET-POINT



ADAPTIVE SET-POINT

An advanced algorithm that instantaneously detects the real thermal load of the indoor units and then conveys this information to the outdoor chillers, strongly increasing their operation.

- Dynamic variation of the chillers set point and water flow.
- Increasing of the free cooling mode.
- Adoption of the active redundancy system to better exploit stand-by chillers.

DATA CENTER MANAGER (Optional accessory)

DATA CENTER MANAGER is a centralized management system that ensures a smart communication between indoor chilled water units and the outdoor chillers.

The device manages the outdoor units according to the inlet and outlet temperature registered by the probes and by request of the indoor unit.

OPTIONAL ACCESSORIES: 5891 – CONTROL UNIT VIA KIPLINK



Logos, Trademarks and Company Name, are property of the respective Owners.

The optional is factory installed.

KIPLink is an innovative system based on Wi-Fi technology that allows to operate on a unit directly from Smartphone or Tablet via an APP.

WI-FI MODULE:

- Standard: IEEE 802.11n – 802.11g
- Frequencies: 2.4 – 2.4835 GHz
- Output power: <20 dBm (equivalent to <100mW)
- Safety: WPA2
- Flow: < 20m

MEHITS APP

- Operating System: Android 5® or higher, IOS 8® or higher, Windows 10® or higher
- Download: Google Play®, Apple Store® e Microsoft Store®.

HOW TO USE KIPLINK

KIPLink can be used in three ways:

Proximity keyboard:

Approaching the machine with a Smartphone or a Tablet with the MEHITS APP installed, you can connect to the machine via Wi-Fi and you can control it like the standard controller keyboard. It is possible to switch off / on the machine, change sets and reset alarms. Knowing the relative passwords, you access the parameters of the USER, SERVICE and MANUFACTURER menus.

Local Monitoring:

Using a Smartphone, a Tablet or PC connected to the LAN of the building where the machine is also connected. Access is via WEB via a browser. The system has two access profiles: ONLY READ and READ & WRITE.

ONLY READ allows only the visualization of the parameters and it is not possible to control the unit.

READ & WRITE allows you to switch off / on the machine, change sets and reset alarms. Knowing the relative passwords, you access the parameters of the USER, SERVICE and MANUFACTURER menus.

Remote monitoring:

Using a Smartphone, Tablet or PC connected to the VPN of the building where the machine is also connected, it is possible to operate and control from any geographical location where there is an internet connection. Use a secure VPN o avoid access by third parties that could compromise the operation of the machine. The cyber security is in charge of costumer.

DATA STORE

The system can store some data on a 1GB MicroSD card to be installed on the device. The data can be used for Service diagnostics. The card is not provided.

KIPLINK NETWORK

It is possible to set up mixed networks consisting of several KIPLink devices (10 maximum), to display information from different devices (called Client KIPLink) on one single device (called Master KIPLink).

The information is collected from the various Client KIPLink devices connected to EVOLUTION+ / W3000 TE/ CX-4 controllers and sent through the Wi-Fi or Ethernet network to the Master KIPLink device, which stores them and makes them available through an appropriate user interface.

The connection with the Master KIPLink can take place via Wi-Fi, via Ethernet or a combination of the two.

For complete information on the KIPLink system, please consult the relative technical documentation.

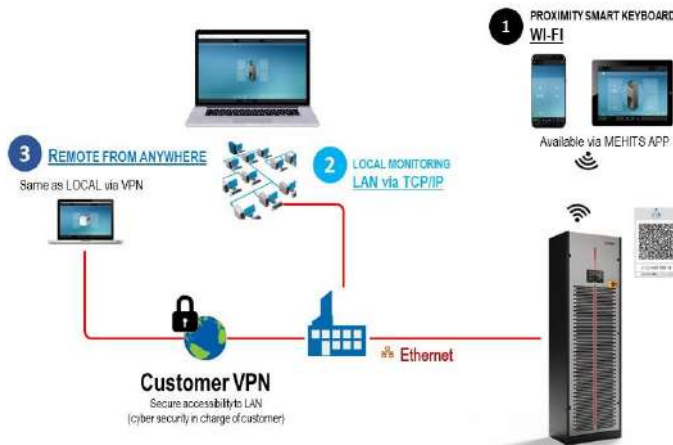

OPTIONAL ACCESSORIES: 6461 – HPC



HPC is the **new advanced and fully integrated control function** designed by MEHITS for hydronic plant optimization. It connects MEHITS chillers and indoor CRAH units without any external devices.

INFRASTRUCTURE

The HPC function is based on LAN groups and the KIPLink network (KIPLAN).

- Every indoor and outdoor unit must be equipped with KIPLink.
- Every outdoor unit must be equipped with Multi Manager.
- HPC supports up to 20 LAN groups of indoor air conditioners (max 15 units per group) and 1 LAN group of outdoor chillers (max 8 units).
- HPC requires a KIPLAN (KIPLink network) made up of one unit per each LAN group. The result is a KIPLAN made of 1 chiller unit (KIP Master), and up to 20 indoor units (KIP Clients).
- KIPLAN network allows HPC data communication between the different LAN groups (indoor and outdoor).

KIPLink allows direct access to all HPC variables and parameters with devoted menus and pages. The most important parameters are also available on the Compact/Large Keyboard.

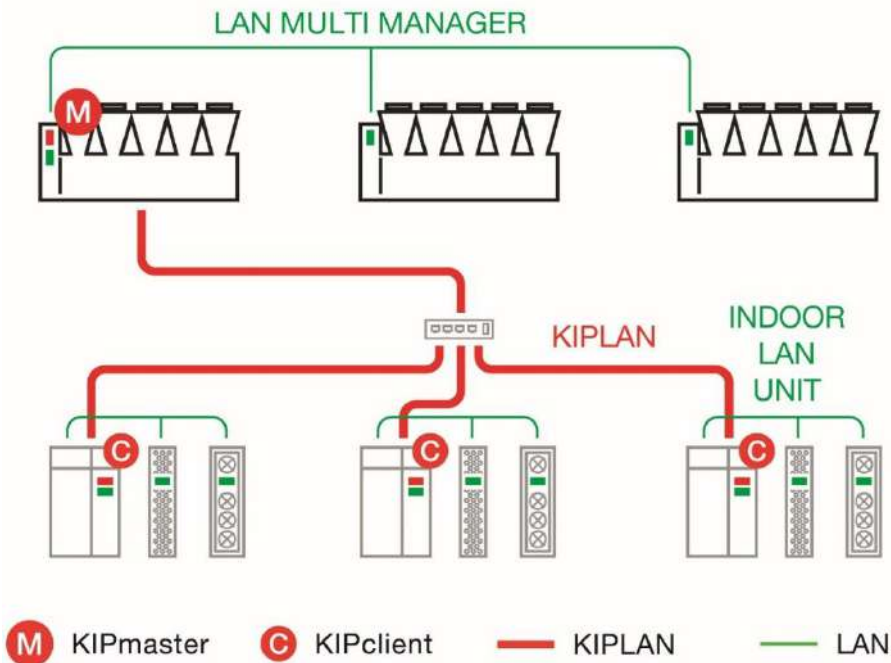

Further information is available in the dedicated Manuals (W3000+, Evolution+, KIPLink).

WORKING LOGICS

The HPC control logics enhance the system efficiency leveraging on partial loads, redundant units, and favourable ambient conditions. HPC acts on time intervals. The time lapse between each HPC action can be set from 1 to 500 minutes. The time left until the AV action is visible in the KIPLink group interface section. According to the instantaneous operating conditions detected in the chilled water system, HPC regulates: the chillers' set-point, the pumps' speed, and the indoor air conditioners' valves and fans.

The main variables taken into consideration are:

- Cooling demand of each indoor unit group (room temperature, fans' speed, valve opening)
- Chilled water temperature
- Pumps' speed
- Chillers' group operating status (outdoor air temperature, FC availability)

The highest benefits are achieved in systems with VSD pumps and free-cooling chillers.

IT cooling load satisfaction is paramount. HPC always gives priority to room cooling dependability. Therefore, actions are taken on the basis of the indoor unit groups' status.

There are 4 operating modes, in order of priority:

1. Reset

When the cooling demand of at least one group of indoor units suddenly increases.

HPC contribution is reset and suspended until the Reset message is active.

The system immediately increases the cooling capacity.

2. Reduce

When the cooling demand of at least one group of indoor units slightly increases.

HPC contribution is reduced. The system increases the cooling capacity.

3. Optimization On

When the cooling demand of all groups of indoor units remains stable or decreases.

HPC optimizes the system by increasing its contribution.

4. No Action

When the cooling demand of all groups of indoor units remains stable or decreases, but HPC has already pushed the system to the best performance achievable in the current conditions.

No further action is taken.



PLUS

- Fully in house developed and patent pending
- Completely integrated, no need for any external devices
- Based on proprietary logics and devices (Multi Manager, KIPlink)
- Energy simulations, comparisons, and payback analysis available on ELCA software
- Ideal to complete the package of a MEHITS chilled water system (chillers and CRAHs)

OPTIONAL ACCESSORIES: A35B – GRAPHIC DISPLAY “Evolution Touch”



The optional is factory installed.
 7” touch-screen graphic display with 16.7 million colors for the management and monitoring of operating and alarm status.
 The Display is equipped with a MicroUSB 2.0 port for the service connection.

The navigation bars are always present on the display to allow quick and intuitive navigation.

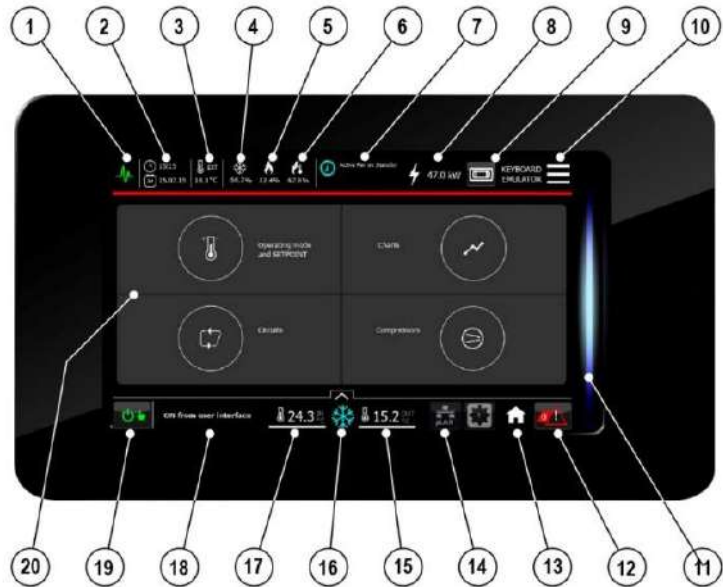

TOP NAVIGATION BAR

1. Status of connection with the controller. Green: connection OK; Red: connection Error
2. Time and date
3. External temperature value by dedicated probe
4. Active percentage of Cooling
5. Active percentage of Heating
6. Active percentage of Post-Heating
7. Unit active functions
8. Power meter readings
9. PGD1 keyboard emulator
10. Rapid access to the menu (Quick menu)

BOTTOM NAVIGATION BAR

11. Light bar for machine status identification
12. Alarm button to access the alarm management screen and the number of active alarms
13. Home button for returning to the Homepage
14. pLAN network
15. Temperature of outlet air or percentage of humidity.
16. Operating mode button.
17. Inlet air temperature
18. Unit status
19. On/Off button

DISPLAY AREA

20. Main menu
 - a. Operating mode and Set-Point
 - b. Circuits
 - c. Charts
 - d. Compressors

For complete information on Graphic Display system, please consult the relative technical documentation.

OPTIONAL ACCESSORIES: A352 - NO DISPLAY

The unit is supplied without display and adjustment is only possible with the KipLink accessory.

OPTIONAL ACCESSORIES: P141 – ANALOGUE SET-POINT COMPENSATION

Analogue set point compensation according to an external analogue signal at Customer care. The microprocessor control, through the additional module "expansion card", can manage a compensation signal of the return air setpoint by analogue input (0...1V; 0...5V; 0,5...4,5V; 4...20mA; 0...20mA). The compensation curve allows to assign a temperature setpoint offset respectively to the minimum and maximum signal managed by the input.

OPTIONAL ACCESSORIES: A842 – NETWORK ANALYZER



INTERNAL installation

The optional is installed within the electrical box downstream the main switch with door safety lock:

- Network transducer.
- Current transformers, one for each power supply phase cable.

This device provides continuous measurement of power consumption, monitoring current, voltage and power. These values are sent to unit microprocessor via RS485 serial cable, as shown on the unit wiring diagram.

The displayed variables are:

- Phase to phase voltage, only for three-phase units.
- Phase voltage (phase-neutral).
- Phase current.
- Neutral current only for three-phase units.
- Active phase power, only for three-phase units.
- Total active power.
- Active energy.
- Hour counts.

OPTIONAL ACCESSORIES: A812 – FREE-COOLING DIRECT CONTROL

Preparation of the machine and the electrical panel for the direct free-cooling system "P034 Intake free-cooling plenum".

OPTIONAL ACCESSORIES: P021 – 2-WAY BALL BYPASS VALVE (Main circuit)



The optional is available for main chilled water circuit only.

2-way modulating motorized valve with 0÷10 VDC control actuator and emergency manual control for the third way (by-pass) of the hydraulic circuit.

The valve is in combination with the main 2-way water flow control valve.

The optional accessory is factory installed and don't modify the overall dimensions of the unit.

The coupling to the main 2-way control valve of a second modulating valve, connected in by-pass, allows to obtain the same control system of a 3-way mixing valve for plant with constant water flow.

At the same time the appropriate sizing of these valves allows hydraulic balancing of the by-pass way.

This type of valve offers the following series of benefits:

- Equal percentage flow control.
- No peaks initial flow.
- Excellent stability control thanks to the integrated characterizing disc.
- Excellent characteristic in partialisation.
- Stability in control.
- Maintenance free.
- Self-cleaning.

CHARACTERISTICS OF THE 2-WAY BALL VALVE

- Closing seal with leakage rate in Class A (EN 12266-1)
- Maximum fluid pressure $P_s=1600\text{kPa}$
- Maximum closing pressure (Close-off) $\Delta P_s=1400\text{kPa}$

The rotative actuator is controlled by a signal 0 ... 10VDC from the microprocessor controller. The actuator is equipped with an emergency button for manual operation and is maintenance-free.

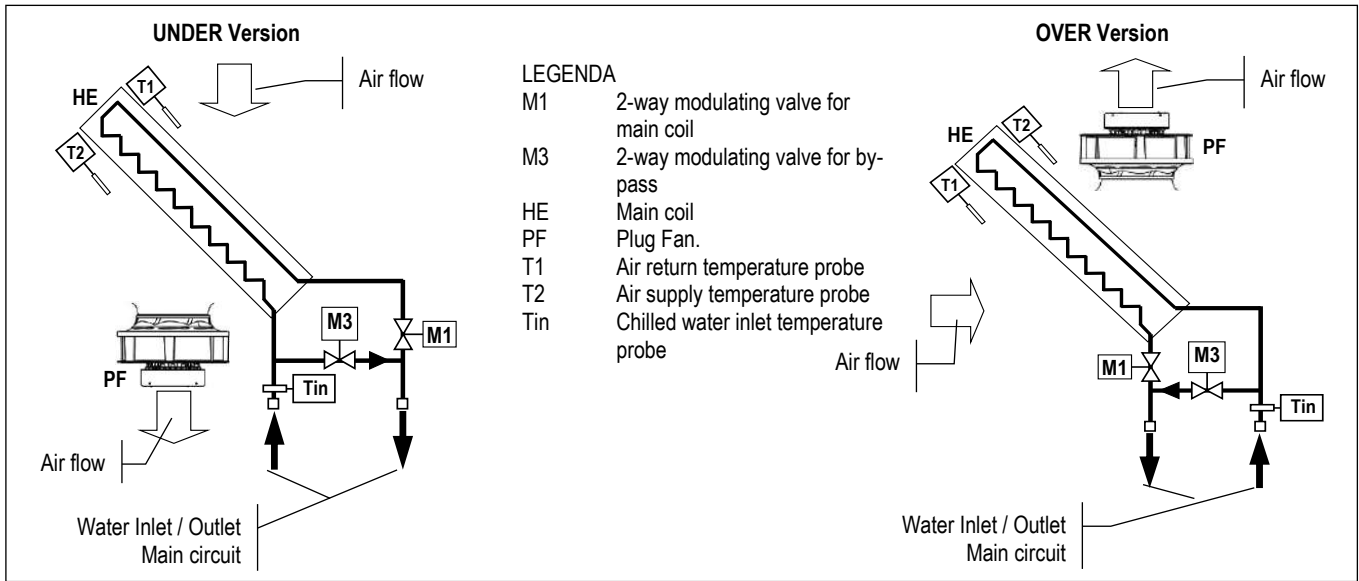

TECHNICAL DATA

VERSION (1)	U / O	U / O	U / O	U / O	U / O	U / O	U / O	U	U	
MODEL	045	053	072	081	100	120	138	160	215	
SIZE	E3P	E4	E5	E6	E7	E8	E9	E10	E10	
2-WAY VALVE FOR BY-PASS										
k_v – Flow coefficient	m ³ /h	8,6	8,6	16,0	16,0	16,0	25,0	25,0	25,0	40,0

1. U = Under, downflow / O = Over, upflow

IMPORTANT

For further information, please refer to chapter “VALVE PRESSURE DROP CALCULATION AS FUNCTION OF WATER FLOW RATE”

OPTIONAL ACCESSORIES: P131 – HOT WATER COIL + 2WAY VALVE



The optional is not available for size E10.

The optional accessory is factory installed and don't modify the overall dimensions of the unit.

Hot water heating system installed downstream the main cooling coil.

Components:

- Heat exchanger coil with internally corrugated copper tubes and high efficiency aluminium fins, specifically developed to provide high heat transfer and lower pressure drops.
- 2-way motorized valve for water flow regulation with 0÷10 VDC control actuator and emergency manual control.
- Temperature probe on water inlet.
- Frame in galvanized steel.

The hot water heating system can be installed in combination with the “A431 electric heater”. The operation is alternate with priority to the hot water heating coil.

It is not possible to combine the “A432 extra power electric heater” with the hot water heating coil. For the water quality of the heating circuit, please refer to the chapter “WATER QUALITY OF THE HYDRAULIC CIRCUITS”.

Temperature control on suction air.

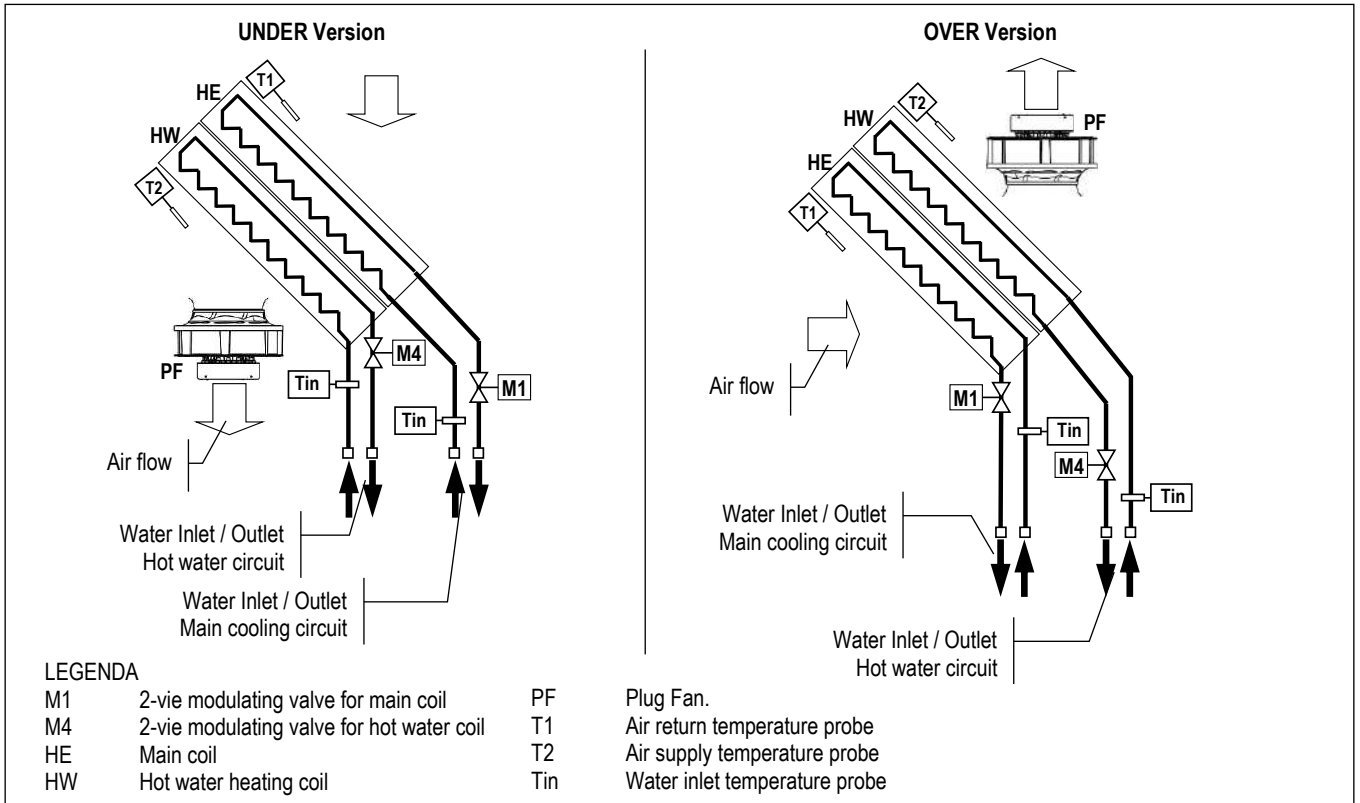

TECHNICAL DATA

VERSION (1)		U / O	U / O	U / O	U / O	U / O	U / O	U / O	U	U
MODEL		045	053	072	081	100	120	138	160	215
SIZE		E3P	E4	E5	E6	E7	E8	E9	E10	E10
THERMAL CAPACITY (2)	kW	85,1	101	131	159	182	215	255	--	--
HEATING COIL										
Water flow rate (2)	m ³ /h	7,5	8,9	11,4	13,9	15,9	18,8	22,4	--	--
dP coil + valve (2)	kPa	31	13,4	27	51,3	8,3	13,4	21,6	--	--
Water volume	l	5,7	6,9	9,1	10,6	12,3	14,2	16,9	--	--
NET WEIGHT (3)	kg	30	35	42	50	57	65	75	--	--
HYDRAULIC CONNECTIONS										
Water Inlet / Outlet ISO 7/1 - R	Ø	1"	1+1/4"	1+1/2"	1+1/2"	2"	2"	2"	--	--

1. U = Under, downflow / O = Over, upflow
2. Characteristics referred to entering air at 20°C-50%UR with hot water temperature 70/60°C - 0% glycol.
3. Value to be added to the weight of the standard unit. Does not include the weight of the water content.

2-WAY BALL VALVE FOR HOT WATER FLOW CONTROL



The water flow control in the finned coil is achieved through a **2-way modulating ball valve with equal percentage flow control** ensured by the integrated characterizing disc.

This type of valve offers the following series of benefits:

- Equal percentage flow control.
- No peaks initial flow.
- Excellent stability control thanks to the integrated characterizing disc.
- Excellent characteristic in partialisation.
- Stability in control.
- Maintenance free.
- Self-cleaning.

CHARACTERISTICS OF THE 2-WAY BALL VALVE

- Closing seal with leakage rate in Class A (EN 12266-1)
- Maximum fluid pressure Ps=1600kPa
- Maximum closing pressure (Close-off) ΔPs=1400kPa

The rotative actuator is controlled by a signal 0 ... 10VDC from the microprocessor controller. The actuator is equipped with an emergency button for manual operation and is maintenance-free.

OPTIONAL ACCESSORIES: A431 - ELECTRIC HEATERS

OPTIONAL ACCESSORIES: A432 - EXTRA POWER ELECTRIC HEATERS



A431 – ELECTRIC HEATERS

Electric heater consisting of finned aluminum elements, ensuring low surface temperature and deleting the air ionization problems. The optional is installed downstream the main cooling coil. In electric heaters with three working steps the activation is binary type.

Components:

- Electric heater in aluminium armoured elements with integral fins
- Electrical control
- Safety thermostat.

The electric heater can be installed in combination with the “P131 hot water coil + 2-way valve”. The operation is alternate with priority to the hot water heating coil.

Temperature control on suction air.

TECHNICAL DATA

VERSION (1)		U / O	U / O	U / O	U / O	U / O	U / O	U / O	U	U
MODEL		045	053	072	081	100	120	138	160	215
SIZE		E3P	E4	E5	E6	E7	E8	E9	E10	E10
THERMAL CAPACITY	kW	6,0	9,0	13,5	13,5	13,5	18,0	18,0	27,0	27,0
Absorbed current (OA)	A	8,7	13,0	19,5	19,5	19,5	26,0	26,0	39,0	39,0
First working step	kW	3,0	3,0	4,5	4,5	4,5	4,5	4,5	9,0	9,0
Second working step	kW	3,0+3,0	6,0	9,0	9,0	9,0	13,5	13,5	18,0	18,0
Third working step	kW	–	3,0+6,0	4,5+9,0	4,5+9,0	4,5+9,0	4,5+13,5	4,5+13,5	9,0+18,0	9,0+18,0
NET WEIGHT (2)	kg	7	9,5	10	9,5	9,5	11	11	15	15

1. U = Under, downflow / O = Over, upflow
2. Value to be added to the weight of the standard unit.

A432 – EXTRA POWER ELECTRIC HEATERS

The components are the same standard accessory.

It is not possible to combine the extra power electric heaters with the “P131 hot water coil + 2-way valve”

Temperature control on suction air.

TECHNICAL DATA

VERSION (1)		U / O	U / O	U / O	U / O	U / O	U / O	U / O	U	U
MODEL		045	053	072	081	100	120	138	160	215
SIZE		E3P	E4	E5	E6	E7	E8	E9	E10	E10
THERMAL CAPACITY	kW	9,0	13,5	18,0	18,0	18,0	27,0	27,0	36,0	36,0
Absorbed current (OA)	A	13,0	19,5	26,0	26,0	26,0	39,0	39,0	52	52
First working step	kW	4,5	4,5	4,5	4,5	4,5	9,0	9,0	13,5	13,5
Second working step	kW	4,5+4,5	9,0	13,5	13,5	13,5	18,0	18,0	22,5	22,5
Third working step	kW	–	4,5+9,0	4,5+13,5	4,5+13,5	4,5+13,5	9,0+18,0	9,0+18,0	13,5+22,5	13,5+22,5
NET WEIGHT (2)	kg	7	9,5	12	11,5	11,5	14,5	14,5	18,5	18,5

1. U = Under, downflow / O = Over, upflow
2. Value to be added to the weight of the standard unit.

OPTIONAL ACCESSORIES: 4301 – STEAM HUMIDIFIER 3KG/H
OPTIONAL ACCESSORIES: 4303 – STEAM HUMIDIFIER 8KG/H
OPTIONAL ACCESSORIES: 4305 – STEAM HUMIDIFIER 15KG/H

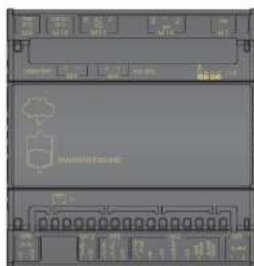

Humidifier control board

Modulating steam humidifier with immersed electrodes fitted with safety and running accessories. The optional includes the control board. The optional requires mandatory accessory "P161 T/rH air intake sensor". The optional is factory installed and requires only water filling connection.

Humidifier water charge and discharge pipes are not supplied.

It is recommended to install a filter and a shut-off valve on the pipe to the water inlet.

This humidifier produces non-pressurized steam by electrodes immersed in the water inside the cylinder: they bring the electric phase in the water that works as an electrical resistance and overheats. The steam so produced is distributed with dedicated distributors and used for ambient humidification or for industrial processes.

CHARACTERISTICS OF THE SUPPLY WATER

The quality of the used water influences the evaporation process, so the humidifier can be fed with **not-treated water, only when potable and non-demineralised.**

LIMIT VALUES

		Min	Max
Hydrogen ions	pH	7	8,5
Specific conductivity at 20°C	$\sigma_{R, 20^\circ C}$ $\mu S/cm$	350	750
Total dissolved solids	TDS mg/l	(1)	(1)
Dry residue at 180°C	R ₁₈₀ mg/l	(1)	(1)
Total hardness	TH mg/l CaCO ₃	100 (2)	400
Temporary hardness	mg/l CaCO ₃	60 (3)	300
Iron + Manganese	mg/l Fe + Mn	0	0,2
Chlorides	ppm Cl	0	30
Silica	mg/l SiO ₂	0	20
Residual chlorine	mg/l Cl ⁻	0	0,2
Calcium sulphate	mg/l CaSO ₄	0	100
Metallic impurities	mg/l	0	0
Solvents, diluents, soaps, lubricants	mg/l	0	0

(1) Values depending on specific conductivity; in general: TDS \cong 0,93 * $\sigma_{R, 20^\circ C}$; R₁₈₀ \cong 0,65 * $\sigma_{R, 20^\circ C}$

(2) Not lower than 200% of the chloride content in mg/l di Cl⁻

(3) Not lower than 300% of the chloride content in mg/l di Cl⁻

WARNING:

- Use only with drinking water.
- There is no reliable relationship between hardness and water conductivity
- Do not treat water with softeners! This could cause corrosion of the electrodes or the formation of foam, leading to potential operating problems or failures.
- Do not add disinfectants or corrosion inhibitors to water, as these substances are potentially irritant.
- Is absolutely forbidden to use well water, industrial water or water drawn from cooling circuits; in general, avoid using potentially contaminated water, either from a chemical or bacteriological point of view.

TECHNICAL DATA

VERSION (1)		U / O	U / O	U / O	U / O	U / O	U / O	U / O	U	U
MODEL		045	053	072	081	100	120	138	160	215
SIZE		E3P	E4	E5	E6	E7	E8	E9	E10	E10
VAPOUR PRODUCTION	kg/h	3,0	8,0	8,0	8,0	15,0	15,0	15,0	15,0	15,0
Power input	kW	2,3	6,0	6,0	6,0	11,3	11,3	11,3	11,3	11,3
Absorbed current (OA)	A	3,2	8,7	8,7	8,7	16,2	16,2	16,2	16,2	16,2
Max absorbed current (FLA)	A	4,5	12,4	12,4	12,4	23,0	23,0	23,0	23,0	23,0
Water content	l	3,9	6,4	6,4	6,4	10,3	10,3	10,3	10,3	10,3
Max water supply pressure	Bar	1÷8	1÷8	1÷8	1÷8	1÷8	1÷8	1÷8	1÷8	1÷8
NET WEIGHT (2)	kg	6	10	12	14	16	18	20	20	20
HYDRAULIC CONNECTION										
WATER INLET - ISO 228/1 – G M	Ø	3/4"	3/4"	3/4"	3/4"	3/4"	3/4"	3/4"	3/4"	3/4"
WATER OUTLET - external diameter	Ø mm	19	19	19	19	19	19	19	19	19

1. U = Under, downflow / O = Over, upflow

2. Value to be added to the weight of the standard unit. Does not include the weight of the water content

EXTRA POWER HUMIDIFIER

The optional is not available for sizes E7, E8, E9, E10.
The components are the same standard accessory

TECHNICAL DATA

VERSION (1)		U / O	U / O	U / O	U / O	U / O	U / O	U / O	U	U
MODEL		045	053	072	081	100	120	138	160	215
SIZE		E3P	E4	E5	E6	E7	E8	E9	E10	E10
VAPOUR PRODUCTION	kg/h	8,0	15,0	15,0	15,0	--	--	--	--	--
Power input	kW	6,0	11,3	11,3	11,3	--	--	--	--	--
Absorbed current (OA)	A	8,7	16,2	16,2	16,2	--	--	--	--	--
Max absorbed current (FLA)	A	12,4	23,0	23,0	23,0	--	--	--	--	--
Water content	l	6,4	10,3	10,3	10,3	--	--	--	--	--
Max water supply pressure	Bar	1÷8	1÷8	1÷8	1÷8	--	--	--	--	--
NET WEIGHT (2)	kg	10	16	16	16	--	--	--	--	--
HYDRAULIC CONNECTION										
WATER INLET - ISO 228/1 – G M	Ø	3/4"	3/4"	3/4"	3/4"	--	--	--	--	--
WATER OUTLET - external diameter	Ø mm	19	19	19	19	--	--	--	--	--

1. U = Under, downflow / O = Over, upflow
2. Value to be added to the weight of the standard unit. Does not include the weight of the water content.

OPTIONAL ACCESSORIES: P051 – DEHUMIDIFICATION FUNCTION

The optional requires mandatory accessory "P161 T/rH air intake sensor".

Components:

- T/rH air intake sensor.
- Temperature sensor on cooling coil water inlet / outlet.
- Electronic control system of the dew point temperature for the combined intervention of cooling capacity and air flow.
-

OPTIONAL ACCESSORIES: P161 - T/RH AIR INTAKE SENSOR

P161: T/RH AIR INTAKE SENSOR

The accessory replaces the temperature sensor installed on the air intake in the unit and allows the displaying of the relative humidity room value

The sensor is mandatorily required with following option:

- 4301 / 4303 / 4305 Humidifier;
- P161 Dehumidification function;
- P034 Intake free-cooling plenum.

OPTIONAL ACCESSORIES: P071 / P072 / P073 / P074 - REMOTE T/RH PROBE



In addition to the on-board temperature probes, the unit's control can manage up to 4 remote T/RH probes (optional), to measure the return and the delivery air temperature in different positions. Depending on the individual characteristics of the room and the cooling equipment, the customer can choose where to install the additional probes to achieve best measurement results (N. add. return probes + N. add. delivery probes ≤ 4).

The probes can be configured from the Service menu of the controller.

The probes that are enabled, contribute to the calculation of the return and delivery temperature used for capacity adjustment purposes.

The customer can choose between different types of calculation:

- Temperature of the first probe enabled
- Average temperature of the probes
- Highest temperature of the probes
- Lowest temperature of the probes.

Notes:

If a probe is connected but not enabled, its measurement can still be read on the display and by the BMS, but it is not used to calculate the adjustment temperature. It is possible to disable the probe on the unit and use only the remote probes for capacity adjustment purpose.

- **P071: One** Combined Temperature / Humidity sensor for remote installation. The optional is added to the on-board temperature sensors.
- **P072: Two** Combined Temperature / Humidity sensors for remote installation. The optional is added to the on-board temperature sensors.
- **P073: Three** Combined Temperature / Humidity sensors for remote installation. The optional is added to the on-board temperature sensors.
- **P074: Four** Combined Temperature / Humidity sensors for remote installation. The optional is added to the on-board temperature sensors

OPTIONAL ACCESSORIES: 4666 – EXTERNAL AIR PROBE



The probe must be installed protected against atmospheric agent and allows the displaying of the external air temperature.
 The sensor is mandatorily required with following option:

- P034 Intake free-cooling plenum.

OPTIONAL ACCESSORIES: P111 – DUAL POWER SUPPLY
OPTIONAL ACCESSORIES: P112 – DUAL POWER SUPPLY + OPTIONAL
OPTIONAL ACCESSORIES: P113 – DUAL POWER SUPPLY KIT
OPTIONAL ACCESSORIES: P114 – DUAL POWER SUPPLY KIT + OPTIONAL



The motorised changeover switches automatically manage changeover under load between two three-phase power supplies, or manually for emergency operations.
 These devices are suitable for low voltage systems with interruption of the supply to the load during transfer.
 The model supplied in the automatic version checks the source and switches over automatically, based on configurable parameters.

OPEN TRANSITION TYPE TRANSFER SWITCH WITH A MINIMUM INTERRUPTION OF THE SUPPLY DURING TRANSFER.

To maintain the microprocessor powered and avoid its restarts it is suggested the “P091 Back-up module controller” optional accessory. The back-up module guarantees the microprocessor power supply for a few minutes, in case of supply voltage failure.

INSTALLATION

Frame	Power Supply	Installation	Code
E3P	400/3+N/50	EXTERNAL to the unit, supplied in kit	P113, P114 (*)
E4	400/3+N/50	EXTERNAL to the unit, supplied in kit	P113, P114 (*)
E5	400/3+N/50	INTERNAL (on unit electrical panel)	P111, P112 (*)
E6	400/3+N/50	INTERNAL (on unit electrical panel)	P111, P112 (*)
E7	400/3+N/50	INTERNAL (on unit electrical panel)	P111, P112 (*)
E8	400/3+N/50	INTERNAL (on unit electrical panel)	P111, P112 (*)
E9	400/3+N/50	INTERNAL (on unit electrical panel)	P111, P112 (*)
E10	400/3+N/50	INTERNAL (on unit electrical panel)	P111, P112 (*)

(*) P112, P114 for units with optional (with electric heaters and/or humidifier)

MOUNTING KIT

For EXTERNAL installation, the optional accessory is supplied in special box with IP 3X ingress protection, with the dimensions shown in the figure below.

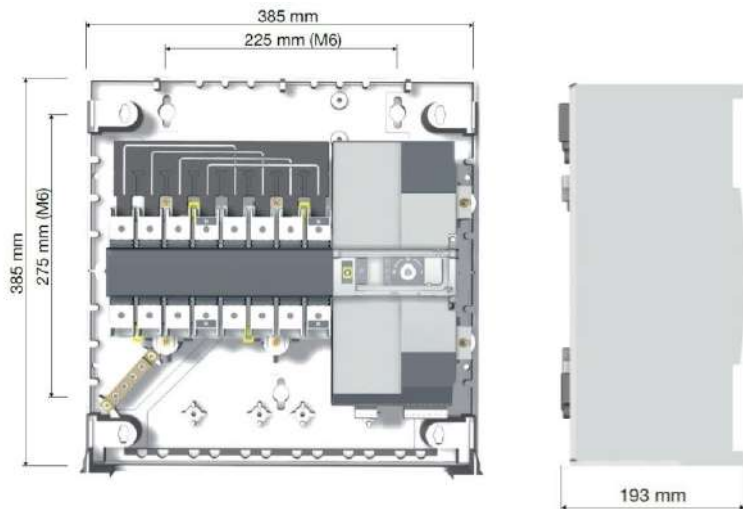

OPTIONAL ACCESSORIES: A381 - DRAIN PUMP



The optional is supplied in mounting kit.
 A plastic case contains the vertical type pump, the water tank with float plus safety switch and hydraulic and electric connection.
 Together the pump 10 linear meters anti-crushing plastic discharge spiral tube is supplied
 The optional must be installed as shown in the documentation delivered together with the unit.
 Wiring includes power supply and an alarm, displayed on microprocessor, that includes motor pump thermal protection and tank overflow.
 The condensate discharge pump operation is fully automatic.

TECHNICAL DATA

- Power supply: 230V~ 50Hz
- Electrical data: 70W – 0,67A
- Maximum water flow: 500 l/h
- Maximum delivery height: 5.0 m
- Sound level: 45dBA a 1 m
- Maximum water temperature: 70°C
- Water acidity: pH>2.5
- Tray volume: 2.0 l
- Protection IP 20

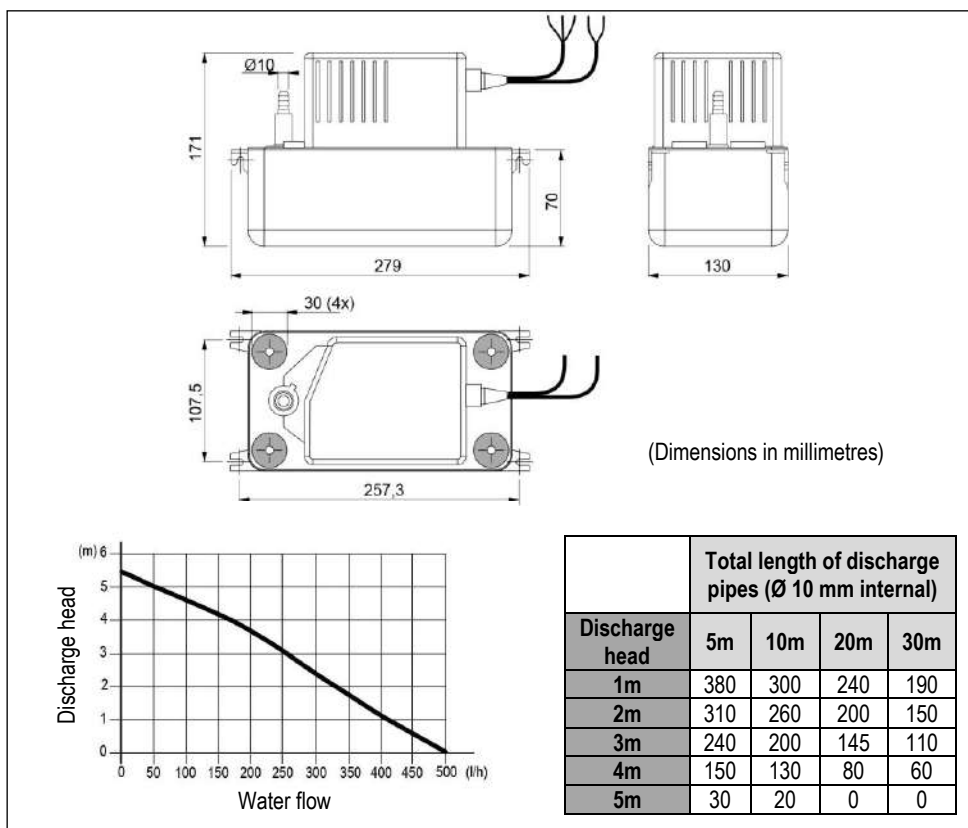

OPTIONAL ACCESSORIES: P084 – AIR FILTER ePM₁₀ 50%

The ePM₁₀ 50% air filters (according to ISO EN 16890), replace the standard one.
 The filters generate a pressure drops higher than the standard ones.
 The filters are made of glass micro-fibre and are not regenerable.

VERSION (1)		U / O	U / O	U / O	U / O	U / O	U / O	U	U	
MODEL		045	053	072	081	100	120	138	160	215
SIZE		E3P	E4	E5	E6	E7	E8	E9	E10	E10
Additional pressure drops (2)	Pa	94	68	65	73	77	60	78	63	63

1. U = Under, downflow / O = Over, upflow
2. Additional pressure drops referred to nominal air flow and clean filter.

OPTIONAL ACCESSORIES: A531 – ON-OFF DAMPER

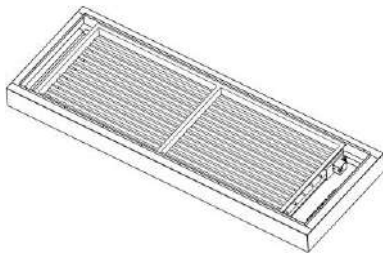

Non-return air damper with frame driven by electric servomotor.
 Accessory installed on unit air delivery and it can be matched to plenums and support frame.
 The accessory requires mandatory accessory "9973 Wooden cage packing".

FRAMEWORK

- Frame in galvanized steel sheet with protective surfaces treatment in compliance with UNI ISO 9227/ASTMB117 and ISO 7253, and painted with epoxy powders. Colour RAL 9005.
- Opposed blade dampers in galvanized steel sheet.
- Actuator for damper control.
- Terminals for electric connection to the unit.

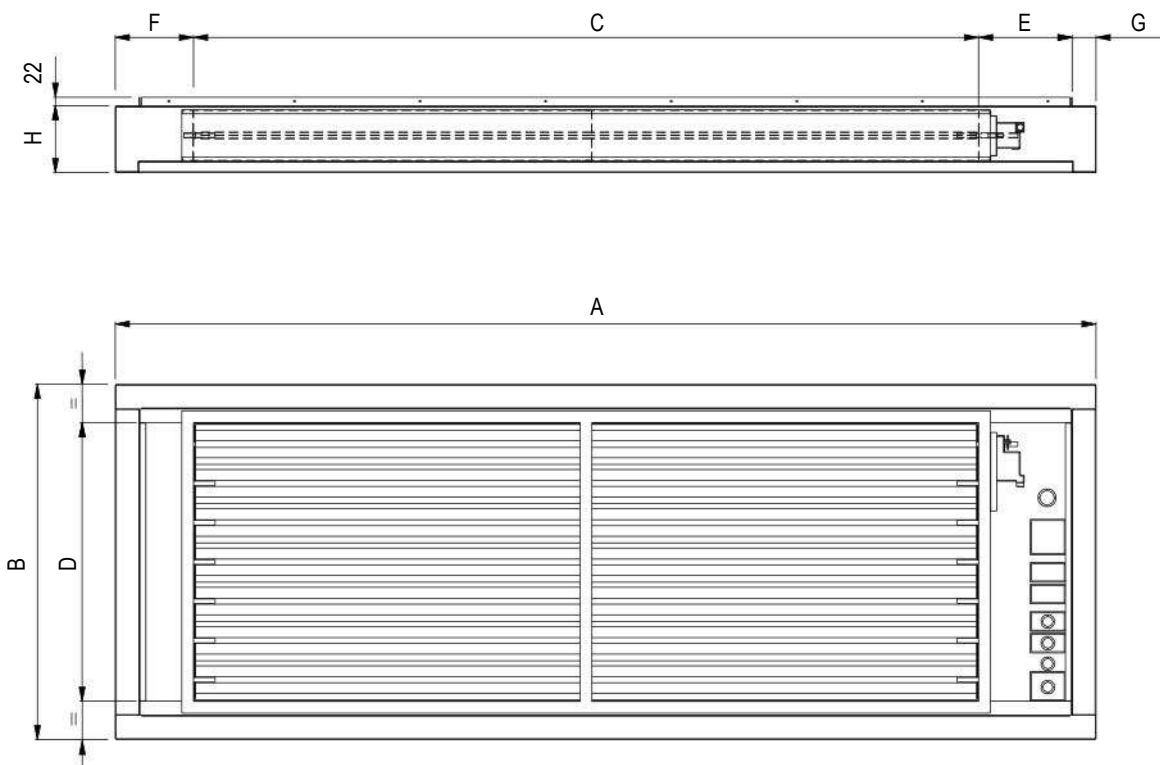

VERSION (1)		U / O	U / O	U / O	U / O	U / O	U / O	U / O	U
SIZE		E3P	E4	E5	E6	E7	E8	E9	E10
A	mm	1085	1305	1630	1873	2175	2499	2899	3510
B	mm	905	905	905	905	905	905	905	905
C	mm	750	900	1250	1500	1750	2000	2300	2800
D	mm	710	710	710	710	710	710	710	710
E	mm	216	142	204	250,5	226,5	238,5	288,5	294
F	mm	73	202	115	61,5	137,5	199,5	249,5	355
G	mm	46	61	61	61	61	61	61	61
H	mm	170	170	170	170	170	170	170	170
Weight (2)	kg	35	40	50	58	65	75	90	115

1. U = Under, downflow / O = Over, upflow
 2. Add this value to the total unit weight

INSTALLATION EXAMPLE

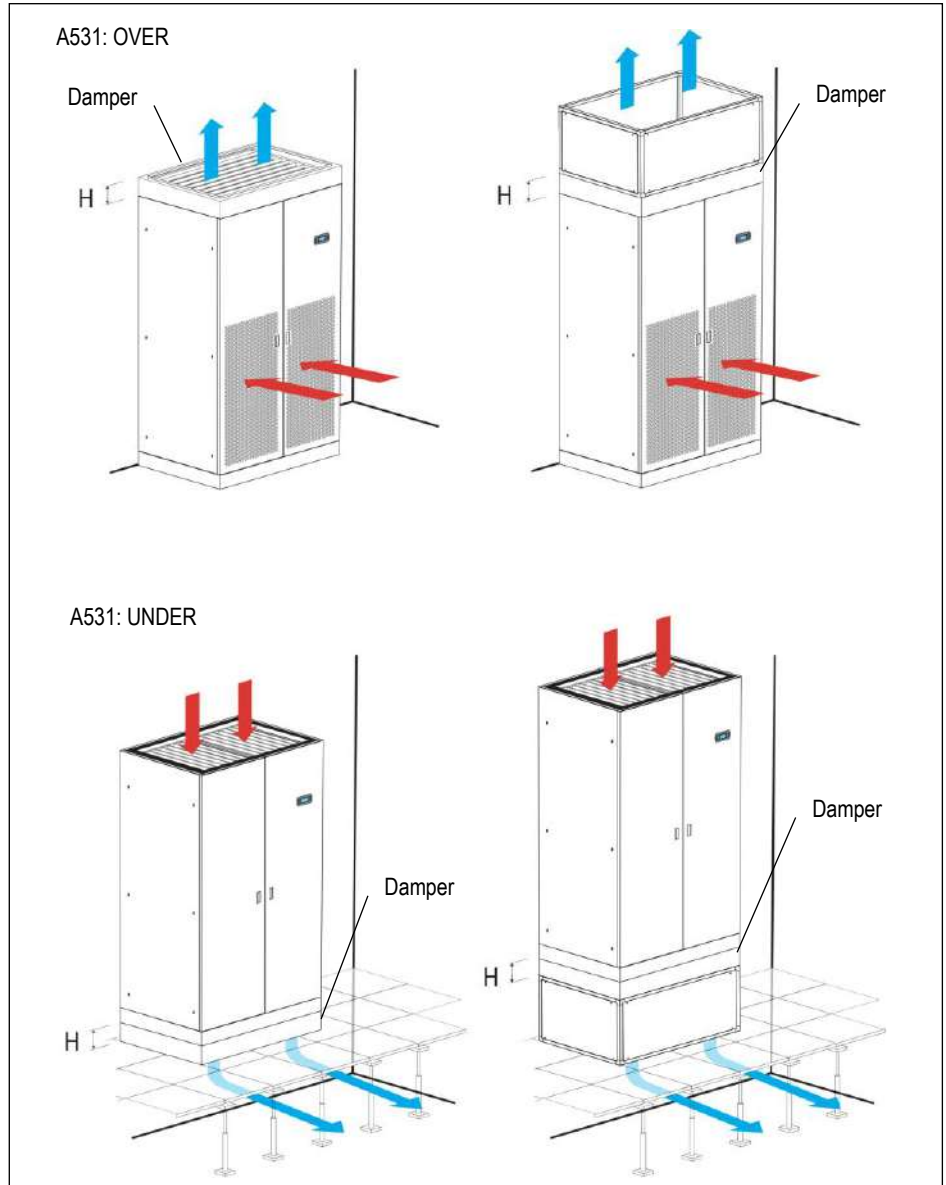

WORKING LOGIC

The damper opens at supply fans activation to allow air flow.

When the fans stop for failure or stop command, the damper closes, preventing air flow into the unit.

- OPTIONAL ACCESSORIES: P011 - EMPTY PLENUM
- OPTIONAL ACCESSORIES: P012 - EMPTY PLENUM CL.A1
- OPTIONAL ACCESSORIES: P031 - EMPTY INTAKE PLENUM
- OPTIONAL ACCESSORIES: P032 - EMPTY INTAKE PLENUM CL.A1
- OPTIONAL ACCESSORIES: P013 - PLENUM + 3 GRILLES
- OPTIONAL ACCESSORIES: P014 - PLENUM + 3 GRILLES CL.A1
- OPTIONAL ACCESSORIES: P015 - SILENCED PLENUM
- OPTIONAL ACCESSORIES: P016 - SILENCED PLENUM + 1 GRILLE
- OPTIONAL ACCESSORIES: P017 - PLENUM + FILTER EPM2.5 50%
- OPTIONAL ACCESSORIES: P018 - PLENUM + FILTER EPM1 50%
- OPTIONAL ACCESSORIES: P019 - PLENUM + FILTER EPM1 85%

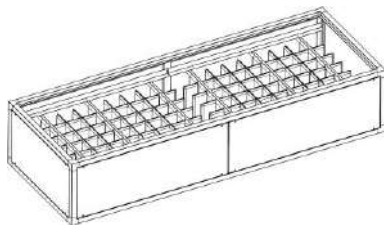
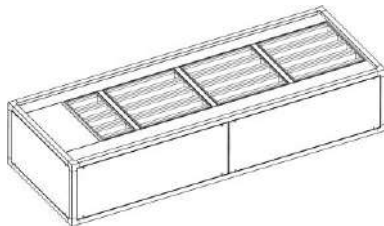
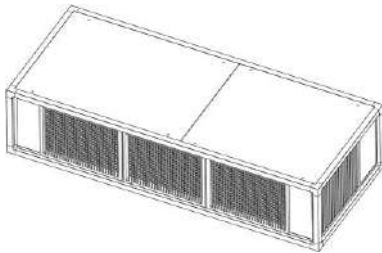
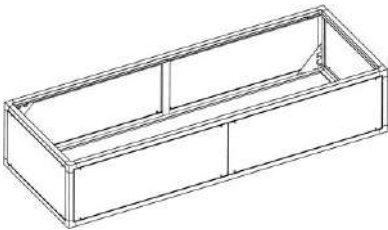

The optional is supplied separately and the installation on the unit is at Customer care.
The plenums have same technical characteristics and base dimensions of the machine cabinet.

It is possible to install only a single plenum to ensure stability to the unit.

FRAMEWORK

- Frame in aluminium extrusion, painted with epoxy powders. Colour RAL 9005.
- Panels in galvanized steel sheet with protective surfaces treatment in compliance with UNI ISO 9227/ASTMB117 and ISO 7253, and painted with epoxy powders. Colour RAL 9005.
- Panels insulated with polyurethane foam and seals to ensure airtight.
- Panels fixed with screws.
- Removable panels.
- Set of fixing elements to fasten the plenum to the unit.

WARNING

In UNDER version units the hydraulic piping is inside the machine.

The air delivery plenums sometime don't allow the extension of the pipes downwards.

In special cases, to keep the connections inside the machine, foresee a plenum 200mm higher than the standard one.

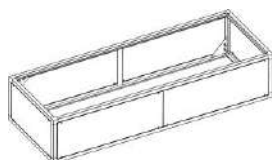

P011 / P012 – P031 / P032: EMPTY PLENUM

The plenum is void and can be used to rise the intake/delivery air inlet/outlet.

Remove the frontal panels for inspection.

Also available with fire reaction in class “0” or “A1” (EN 13501-1).

The optional accessories “P031 Empty intake plenum, for OVER version” and “P032 Empty intake plenum CL.A1, for OVER version” require mandatory accessory “P122 Bottom air intake+blind panels, for OVER version only”.

P011 / P012 OVER

P031 / P032 OVER

P011 / P012 UNDER

P031 / P032 UNDER

VERSION (1)		U / O	U / O	U / O	U / O	U / O	U / O	U / O	U
SIZE		E3P	E4	E5	E6	E7	E8	E9	E10
A	mm	510	510	510	510	510	510	510	510
Weight (2)	kg	25	30	40	45	50	60	70	78
Weight CL.0 or A1 (EN 13501-1) (2)	kg	33	39	50	56	62	74	85	96

1. U = Under, downflow / O = Over, upflow
 2. Add this value to the total unit weight

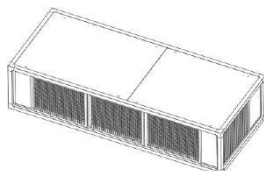

P013 / P014: PLENUM + 3 GRILLES

The plenum must be installed on air delivery.

The plenum allows the air distribution directly into the room. The plenum is supplied with air distribution grilles with double row adjustable grilles on front and lateral side.

Also available with fire reaction in class “0” or “A1” (EN 13501-1).

P013 / P014 OVER

P013 / P014 UNDER

VERSION (1)		U / O	U / O	U / O	U / O	U / O	U / O	U / O	U
SIZE		E3P	E4	E5	E6	E7	E8	E9	E10
A	m	510	510	510	510	510	510	510	510
Weight (2)	kg	36	45	50	65	75	90	100	120
Weight CL.0 or A1 (EN 13501-1) (2)	kg	44	54	61	77	89	106	118	142

1. U = Under, downflow / O = Over, upflow
 2. Add this value to the total unit weight

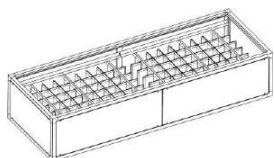

P015: SILENCED PLENUM

The plenum must be installed on air delivery.
The plenum is fitted with noise absorption partitions to reduce the noise emission.
Remove the frontal panels for inspection.

P015 OVER

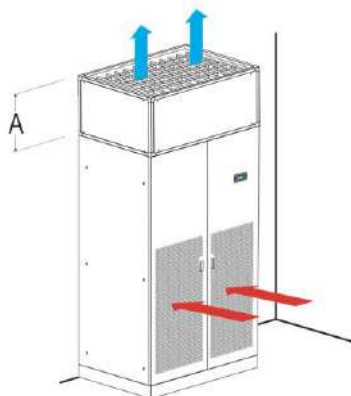

P015 UNDER

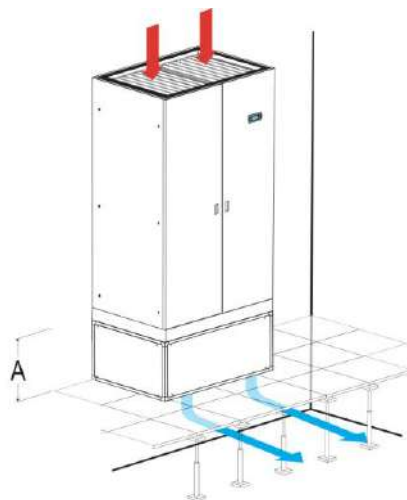

VERSION (1)		U / O	U / O	U / O	U / O	U / O	U / O	U / O	U
SIZE		E3P	E4	E5	E6	E7	E8	E9	E10
A	mm	510	510	510	510	510	510	510	510
Weight (2)	kg	36	45	50	65	80	90	100	120

1. U = Under, downflow / O = Over, upflow
2. Add this value to the total unit weight

ACOUSTIC DATA

VERSION (1)		U / O	U / O	U / O	U / O	U / O	U / O	U / O	U	U
MODEL		045	053	072	081	100	120	138	160	215
SIZE		E3P	E4	E5	E6	E7	E8	E9	E10	E10
NOISE LEVEL (2)										
On air delivery Under	dB(A)	74,5	75,1	75,5	75,9	76,9	80,3	79,8	79,1	79,1
On air intake Under	dB(A)	66,2	66,7	65,6	67,5	68,5	70,4	71,4	70,7	70,7
On front side Under	dB(A)	56,7	57,2	56,0	58,1	59,0	60,8	61,9	61,2	61,2
On air delivery Over	dB(A)	74,5	75,1	75,5	75,9	76,9	80,3	79,8	--	--
On air intake Over (3)	dB(A)	60,7	61,2	60,1	62,1	63,0	64,9	62,6	--	--
On front side Over (4)	dB(A)	56,7	57,2	56,0	58,1	59,0	60,8	58,6	--	--
Additional pressure drops (5)	Pa	60	64	63	72	79	61	82	131	131
Air flow	m ³ /h	10800	13100	16350	20000	24200	28300	33100	37150	37150

1. U = Under, downflow / O = Over, upflow
2. Noise pressure level at 1 meter in free field – ISO 3744
3. Air intake from the front
4. Air intake from the bottom
5. Value to be subtracted from the nominal external static pressure of the unit.

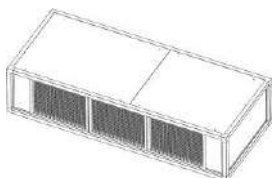

P016: SILENCED PLENUM + 1 GRILLE

The plenum must be installed on air delivery.

The plenum allows the frontal air distribution directly into the room and a noise reduction of the air delivery. The plenum is supplied with air distribution grille with double row adjustable grilles on front side and noise absorption partitions,

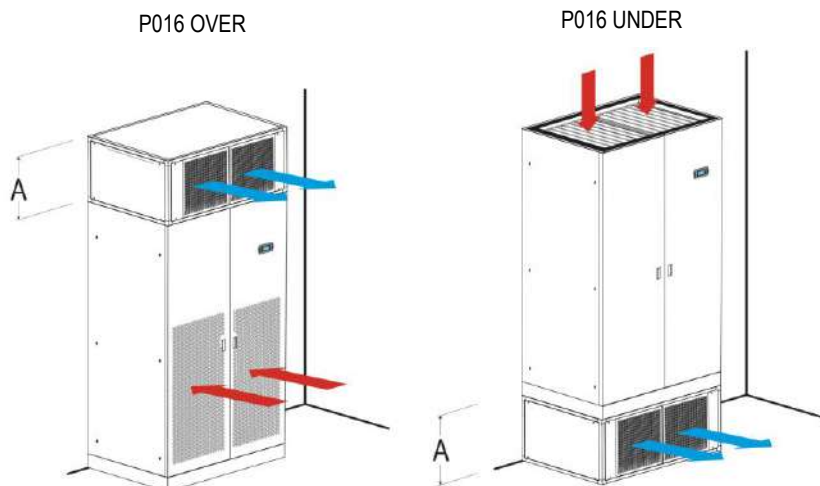

VERSION (1)		U / O	U / O	U / O	U / O	U / O	U / O	U / O	U
SIZE		E3P	E4	E5	E6	E7	E8	E9	E10
A	mm	510	510	510	510	510	510	510	510
Weight (2)	kg	45	67	72	78	88	110	130	150

1. U = Under, downflow / O = Over, upflow
2. Add this value to the total unit weight

ACOUSTIC DATA

VERSION (1)		U / O	U / O	U / O	U / O	U / O	U / O	U / O	U	U
MODEL		045	053	072	081	100	120	138	160	215
SIZE		E3P	E4	E5	E6	E7	E8	E9	E10	E10
SOUND LEVEL (2)										
On air delivery Under	dB(A)	74,0	73,8	75,1	75,4	76,1	79,3	78,8	78,0	78,0
On air intake Under	dB(A)	66,2	66,1	65,9	67,6	68,4	70,0	71,1	70,3	70,3
On front side Under	dB(A)	56,8	56,6	56,3	58,2	58,9	60,5	61,6	60,8	60,8
On air delivery Over	dB(A)	74,0	73,8	75,1	75,4	76,1	79,3	78,8	--	--
On air intake Over (3)	dB(A)	60,8	60,6	60,4	62,2	62,9	64,6	62,6	--	--
On front side Over (4)	dB(A)	56,8	56,6	56,3	58,2	58,9	60,5	58,6	--	--
Additional pressure drops (5)	Pa	150	159	157	178	196	180	204	180	180
Air flow	m ³ /h	10800	12500	16350	20000	23200	27500	32500	35300	35300

1. U = Under, downflow / O = Over, upflow
2. Noise pressure level at 1 meter in free field – ISO 3744
3. Air intake from the front
4. Air intake from the bottom
5. Value to be subtracted from the nominal external static pressure of the unit

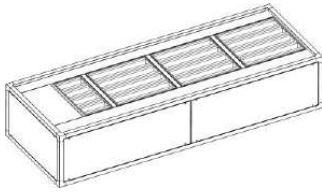

P017 / P018 / P019: PLENUM + FILTER

The plenum must be installed on air delivery.
 The optional is not compatible with "P084 air filter ePM10 50%".
 The plenum is fitted with high efficiency rigid bag filters.
 Filters are made of glass micro fibre and are not regenerable.
 Remove the frontal panels for filters replacement.

P017 / P018 / P019 OVER

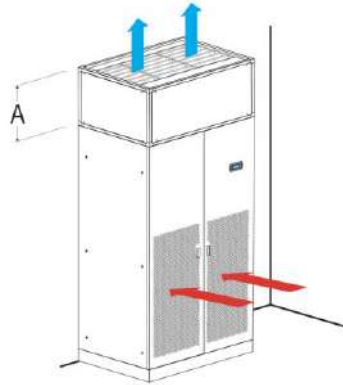

P017 / P018 / P019 UNDER

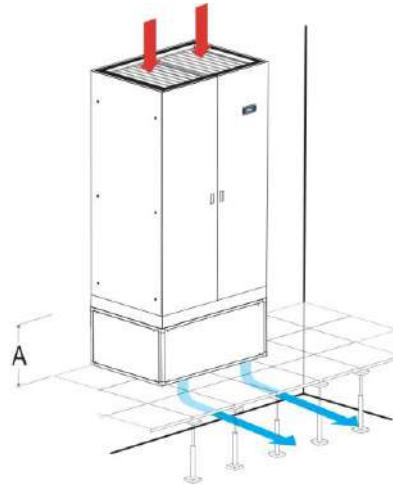

VERSION (1)		U / O	U / O	U / O	U / O	U / O	U / O	U / O	U
SIZE		E3P	E4	E5	E6	E7	E8	E9	E10
A	mm	510	510	510	510	510	510	510	510
Weight (2)	kg	33	45	55	65	80	90	100	120

1. U = Under, downflow / O = Over, upflow
2. Add this value to the total unit weight

VERSION (1)		U / O	U / O	U / O	U / O	U / O	U / O	U / O	U
SIZE		E3P	E4	E5	E6	E7	E8	E9	E10
PRESSURE DROPS (2)									
Filters ISO ePM _{2.5} 50%	Pa	153	137	151	185	165	140	183	145
Filters ISO ePM ₁ 50%	Pa	188	167	186	227	202	176	225	197
Filters ISO ePM ₁ 85%	Pa	228	204	226	295	265	237	272	216

1. U = Under, downflow / O = Over, upflow
2. Data referred to the nominal air flow and clean filters. Value to be subtracted from the nominal external static pressure of the unit.

OPTIONAL ACCESSORIES: P034 – INTAKE FREE-COOLING PLENUM

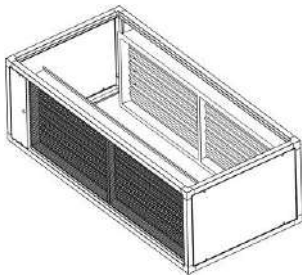
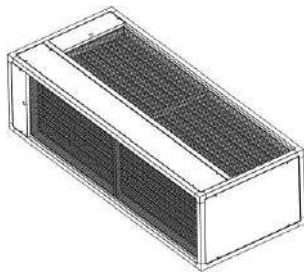

The optional is supplied separately and the installation on the unit is at Customer care.

The optional requires mandatory accessories "P161 T/rH air intake sensor", "4666 External air probe", "A812 Free-cooling direct control" and "P122 Bottom air intake+blind panels, for OVER version only".

The plenums have same technical characteristics and base dimensions of the machine cabinet.

The optional allow to obtain free-cooling by direct ambient air intake into the room.

The dampers are proportionally managed by the microprocessor control, that regulates the quantity of the ambient air to put in the room per the set-point.

COMPONENTS

- Frame in aluminium extrusion, painted with epoxy powders. Colour RAL 9005.
- Panels in galvanized steel sheet with protective surfaces treatment in compliance with UNI ISO 9227/ASTMB117 and ISO 7253, and painted with epoxy powders. Colour RAL 9005.
- Panels insulated with polyurethane foam and seals to ensure airtight.
- Removable panels with screws.
- Opposed blade dampers in galvanized steel sheet and safety grille for ambient air and room air suction.
- Actuator for each damper.
- Terminals for electric connection to the unit.
- Set of fixing elements to fasten the plenum to the unit.
- T/rH air intake sensor. The sensor must be moved outside the air conditioners for a proper read of the room temperature value.
- External air probe. The sensor must be installed in the outdoor air suction duct or anyway protected against atmospheric agent.
- Free contact for free-cooling operating status monitoring.
- Terminals on indoor unit for:
 - 24 Vac power supply for the overpressure damper servomotor
 - 0-10Vdc control signal for the servomotor

INSTALLATION EXAMPLE

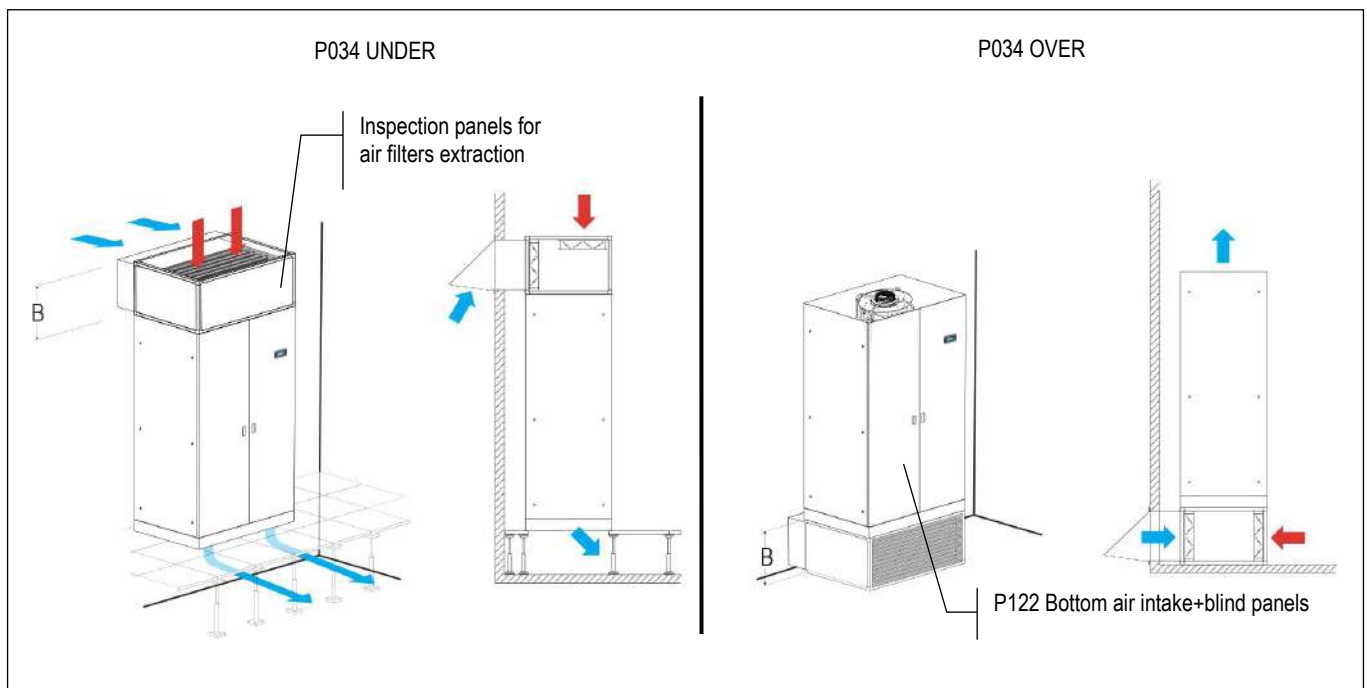

Ducting for ambient air suction are at Customer care.

A rain cover with grille on ambient air intake is recommended.

OVER VERSION

SIZE E3P

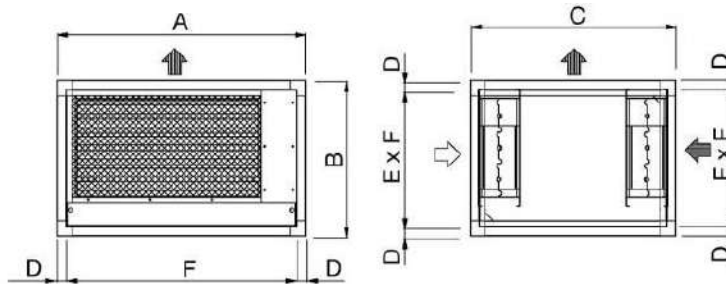

SIZE E4 / E5

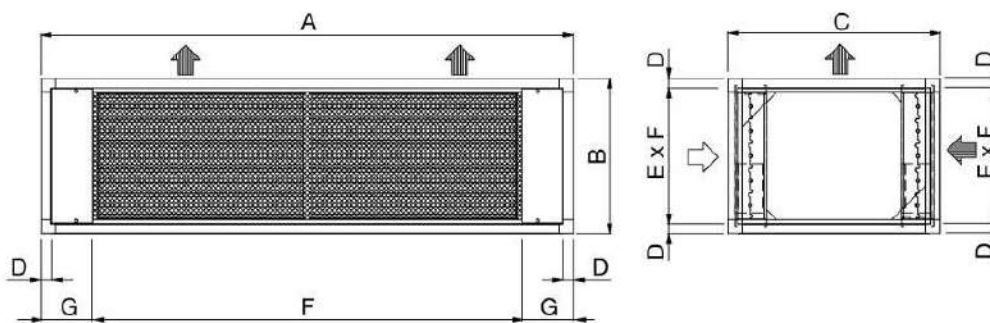

SIZE E6 / E7 / E8 / E9

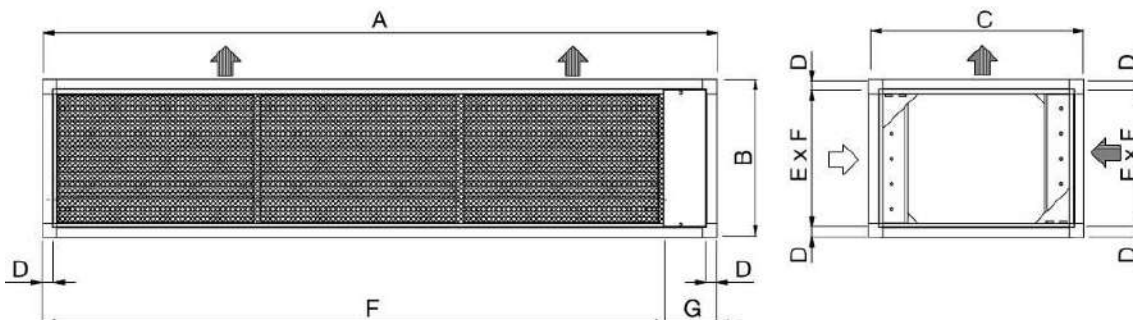

VERSION (1)		O	O	O	O	O	O	O	O
SIZE		E3P	E4	E5	E6	E7	E8	E9	E10
A	mm	1085	1305	1630	1873	2175	2499	2899	--
B	mm	630	630	630	630	630	630	630	--
C	mm	905	905	905	905	905	905	905	--
D	mm	40	40	40	40	40	40	40	--
E	mm	550	550	550	550	550	550	550	--
F	mm	1005	1035	1335	1664	1965	2220	2670	--
G	mm	--	135	147,5	209	210	279	229	--
Weight (2)	kg	43	53	61	78	90	110	130	--

1. U = Under, downflow / O = Over, upflow
2. Add this value to the total unit weight

UNDER VERSION

SIZE E3P

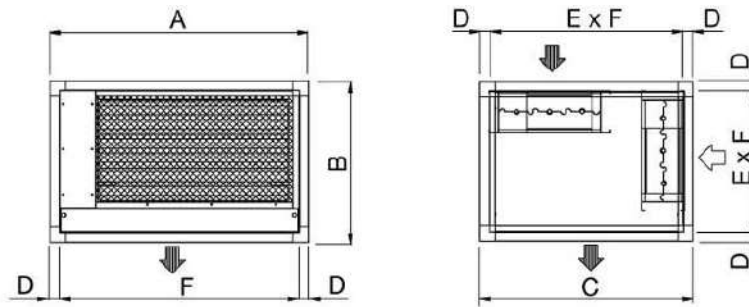

SIZE E4 / E5

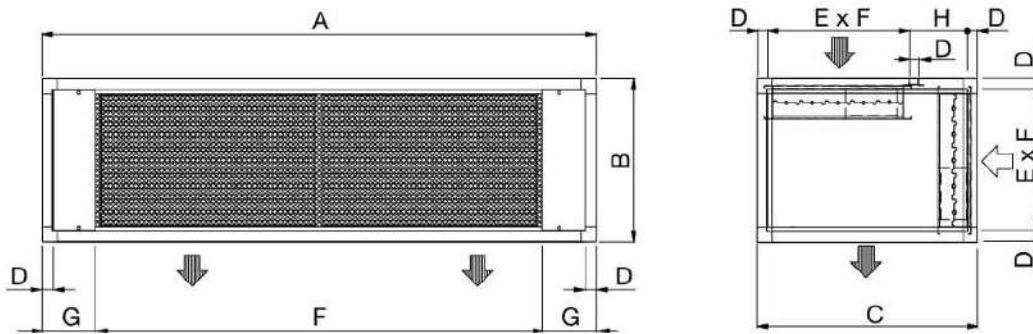

SIZE E6 / E7 / E8 / E9 / E10

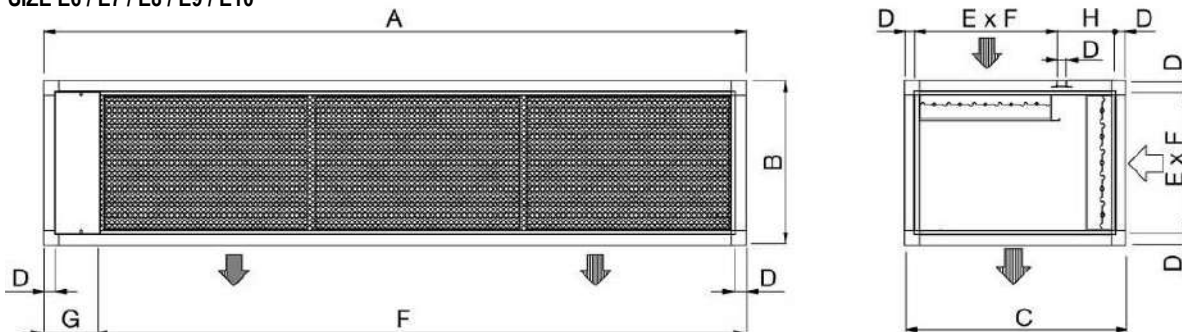

VERSION (1)		U	U	U	U	U	U	U	U
SIZE		E3P	E4	E5	E6	E7	E8	E9	E10
A	mm	1085	1305	1630	1873	2175	2499	2899	3510
B	mm	630	630	630	630	630	630	630	630
C	mm	905	905	905	905	905	905	905	905
D	mm	40	40	40	40	40	40	40	40
E	mm	550	550	550	550	550	550	550	550
F	mm	1005	1035	1335	1664	1965	2220	2670	3135
G	mm	--	135	147,5	209	210	279	229	375
H	mm	275	275	275	275	275	275	275	275
Weight (2)	kg	43	53	61	78	90	110	130	155

1. U = Under, downflow / O = Over, upflow
2. Add this value to the total unit weight

AIR EXHAUSTION DAMPER – Not supplied**WARNING**

IT IS COMPULSORY TO INSTALL IN THE ROOM TO BE CONDITIONED A MOTORIZED DAMPER APPROPRIATELY DIMENSIONED FOR THE EXHAUSTION OF AIR FROM THE ROOM DURING FREE-COOLING OPERATION.

During free-cooling operation, the air conditioner supplies ambient air directly into the room, this causes an increase in air pressure inside the room.

The exhaustion damper avoids the increase in pressure in the room.

The damper must be installed at the highest point of the room to exhaust excess hot air to the outside.

Install the damper if possible, in opposite position to air conditioner.

The damper is controlled by the modulating signal 0-10Vdc of the free-cooling control of the air conditioner. The 24Vac power supply of the servomotor and the 0-10Vdc free-cooling signal is available on the unit's electrical terminal block (see wiring diagram for connections).

Air exhaustion must be protected with a rain cover and a grille (at Customer care).

The electrical connection cables are not supplied.

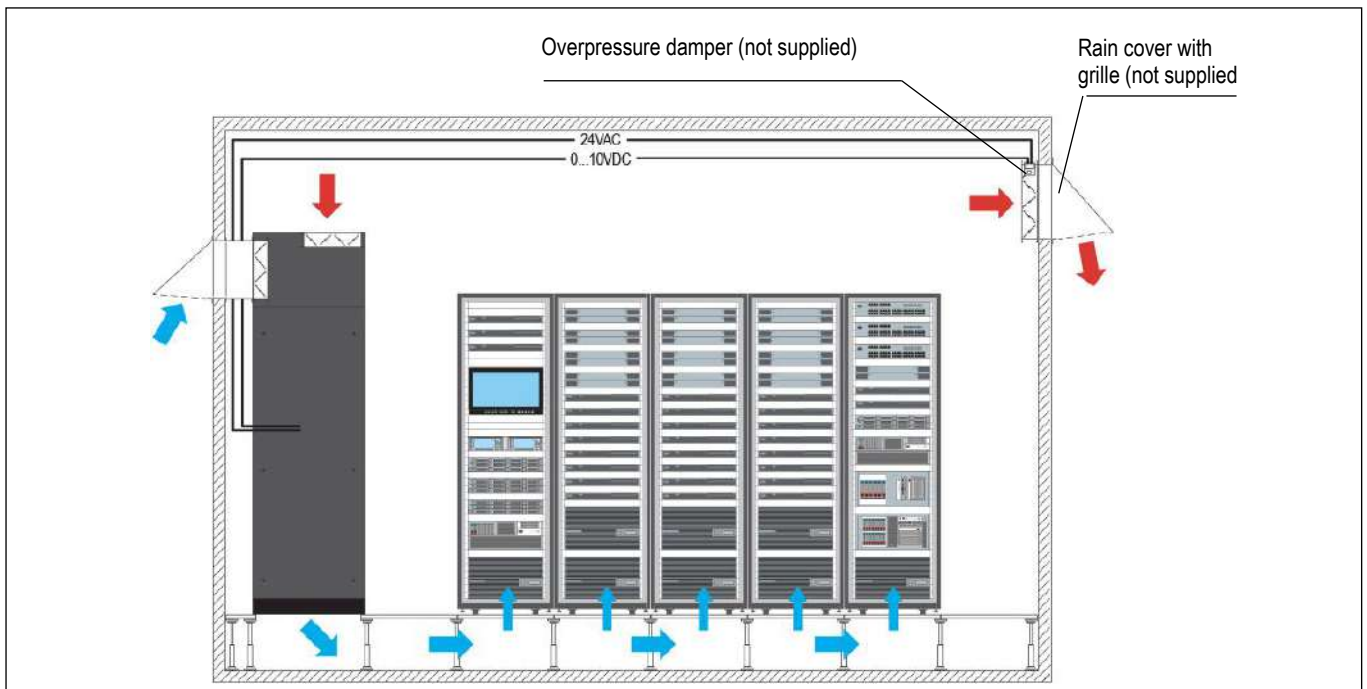

OPTIONAL ACCESSORIES: P041 – SUPPORT FRAME H 255-350MM

OPTIONAL ACCESSORIES: P042 – SUPPORT FRAME H 355-450MM

OPTIONAL ACCESSORIES: P043 – SUPPORT FRAME H 400-510MM

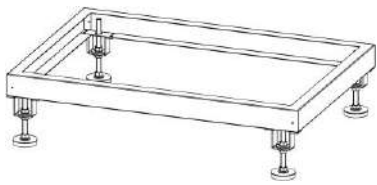

The accessory is supplied as an assembly kit.
It is not possible to match the support frame with plenum installed under the machine.
The floor stand is available in 3 different heights.

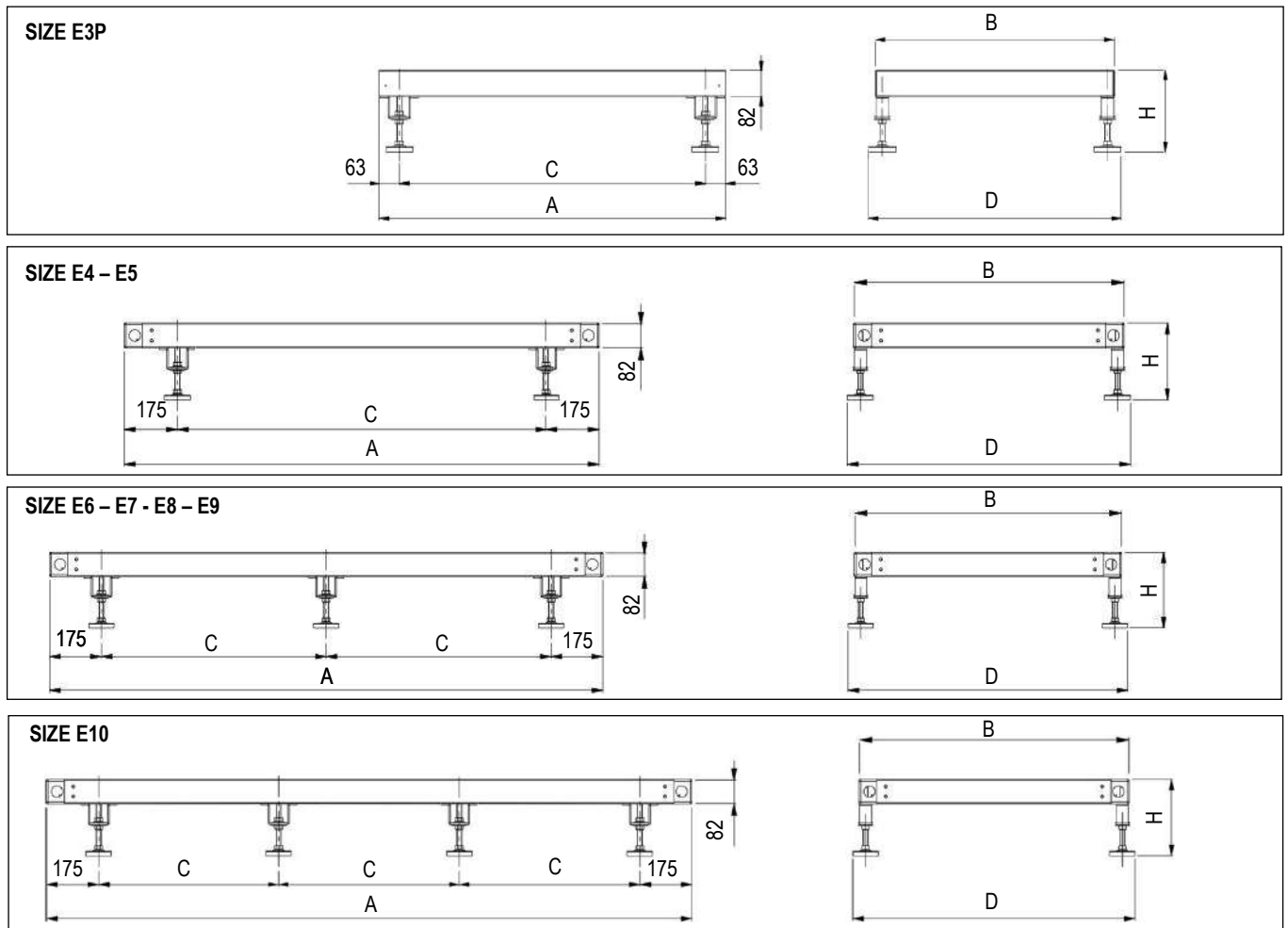

SIZE		E3P	E4	E5	E6	E7	E8	E9	E10
A	mm	1085	1305	1630	1873	2175	2499	2899	3510
B	mm	905	905	905	905	905	905	905	905
C	mm	959	955	1280	761,5	912,5	1074,5	1274,5	1053
D	mm	946	945	945	945	945	945	945	945

MODEL		P041 - Hmax350	P042 - Hmax450	P043 - Hmax510
H min height	mm	255	355	400
H max height	mm	350	450	510

OPTIONAL ACCESSORIES: A272 – CL.0 or A1 (EN13501-1) INSULATION

The optional is designed **TO SUPPLY THE PANELING ONLY WITH FIRE REACTION IN CLASS “0” OR “A1 (EN 13501-1)”**; furthermore, allows a noise insulation of the panels of the air conditioners.

The pressure level reduction of the unit is about 2 dB(A). The reduction refers **ONLY** to the sound level radiated from the unit or in front of the unit. The noise level data on return and delivery air do not undergo reductions.

The accessory includes:

- External part as standard panel.
- Internal part in galvanized steel sheet.
- The inside noise insulation with special soundproof material.

REACTION TO FIRE CLASSIFICATION

On Italian territory, the classification is per the D.M. of June 26, 1984 and subsequent amendments, providing for a sort in "Classes" from 0 (non-combustible material) to 5 (extremely flammable material). The EN 13501-1 regulation is ordered in classes from A1 (non-combustible material) to F (extremely flammable material).

A comparison of the classes is not possible because the methods and evaluation criteria are completely different. The comparison table below is being considered purely indicative.

Definition	Italian classes	EN 13501-1
Non-combustible material	Class 0	A1
Combustible material, very limited contribution to fire	Class 1	A2 – B
Combustible material, limited contribution to fire	Class 2	A2 – B - C
Combustible material, medium contribution to fire	Class 3	C – D
Combustible material, highly contribution to fire	Class 4	E
Combustible material, easily flammable	Class 5	F

Is possible to provide the sandwich panels for the OVER units with air flow from the top.

This implies that the air intake must necessarily be from the base of the unit with front blind panelling.

The accessory increases the unit weight:

OVER									
Size		E3P	E4	E5	E6	E7	E8	E9	E10
Weight increasing (1)	kg	58	64	72	86	100	115	130	--

UNDER									
Size		E3P	E4	E5	E6	E7	E8	E9	E10
Weight increasing (1)	kg	65	70	86	110	130	145	165	195

1. Add this value to the total unit weight

OPTIONAL ACCESSORIES: P151 – LOWERED DISPLAY FOR UNDER

For machines installed above the supply plenum.

The display / keypad on the front panel of the machine is installed lowered by about 50cm to facilitate consultation and use.

MACHINE DRAWINGS

MACHINE DRAWINGS - Dimensions in mm - UNDER E3P

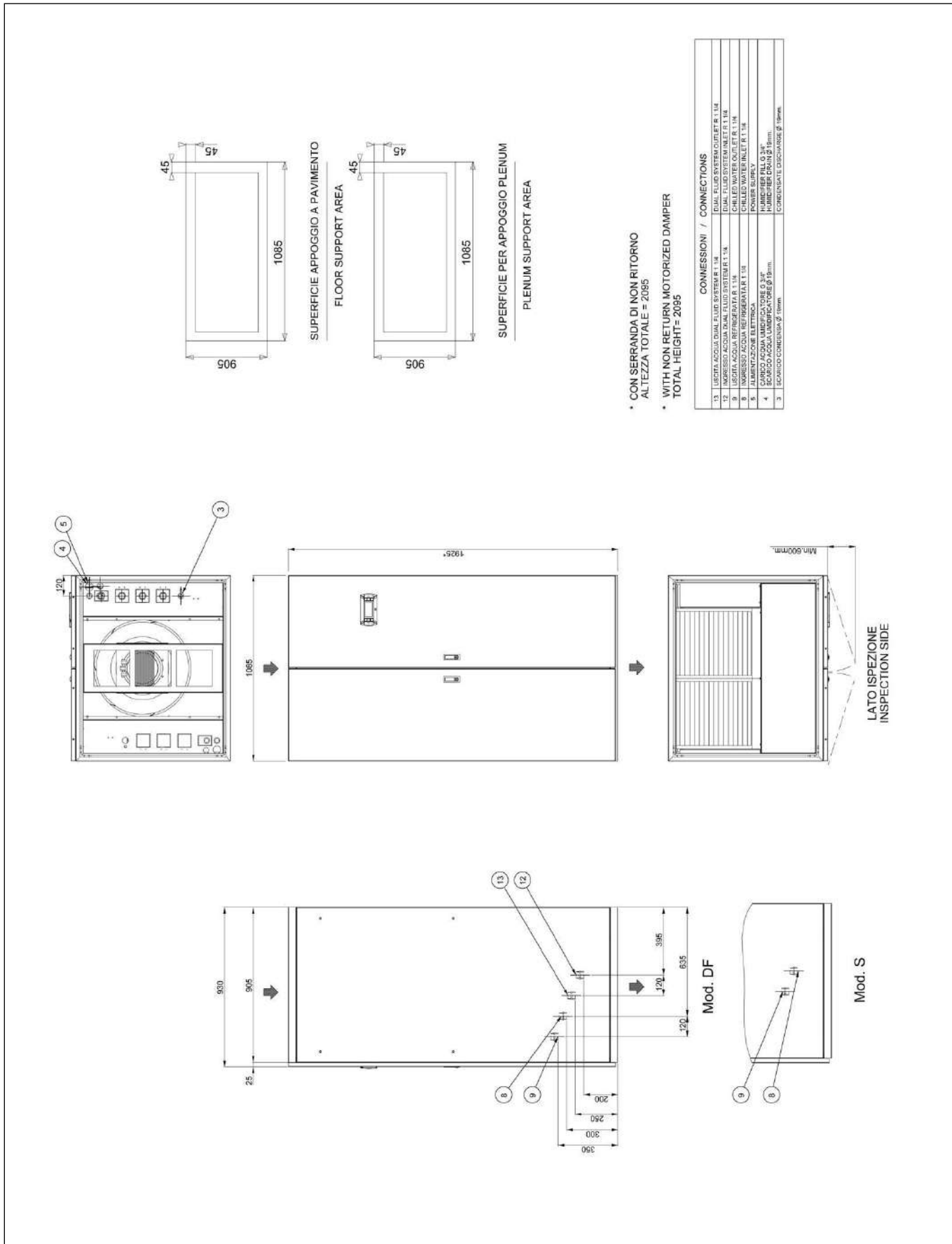

- * CON SERRANDA DI NON RITORNO ALTEZZA TOTALE = 2085
- * WITH NON RETURN MOTORIZED DAMPER TOTAL HEIGHT= 2085

CONNESSIONI / CONNECTIONS	
13	LISCIA ACQUA DUAL FLUID SYSTEM R 1.14 / DUAL FLUID SYSTEM INLET R 1.14
12	IMPIRESSO ACQUA DUAL FLUID SYSTEM R 1.14 / DUAL FLUID SYSTEM INLET R 1.14
9	LISCIA ACQUA REFRIGERANTE R 1.14 / CHILLED WATER INLET R 1.14
8	IMPIRESSO ACQUA REFRIGERANTE R 1.14 / CHILLED WATER INLET R 1.14
5	ALIMENTAZIONE ELETTRICA / POWER SUPPLY
4	SCARICO ACQUA UMIDIFICATORE Ø 19mm / HUMIDIFIER DRAIN Ø 19mm
3	SCARICO CONDENSATA Ø 19mm / CONDENSATE DISCHARGE Ø 19mm

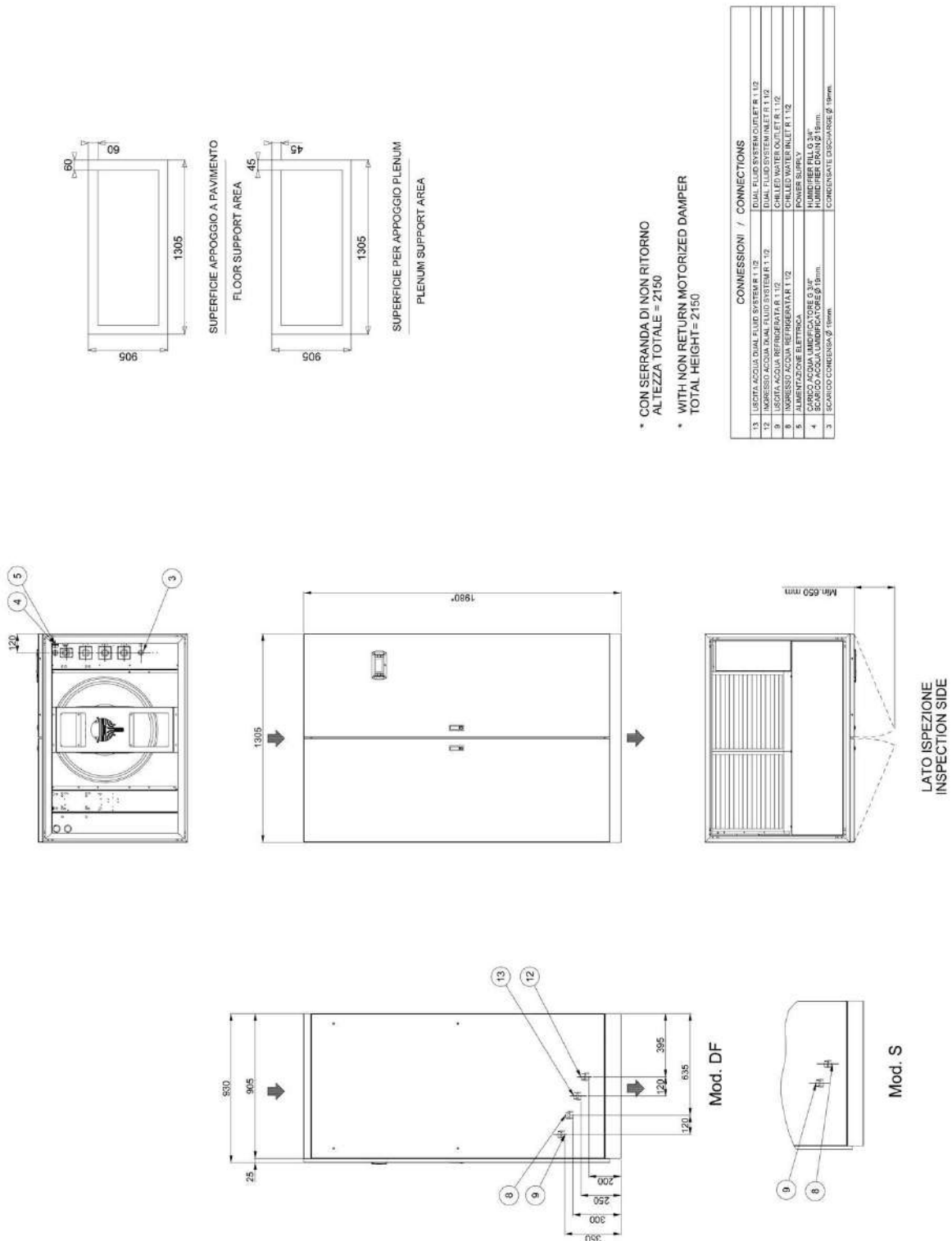

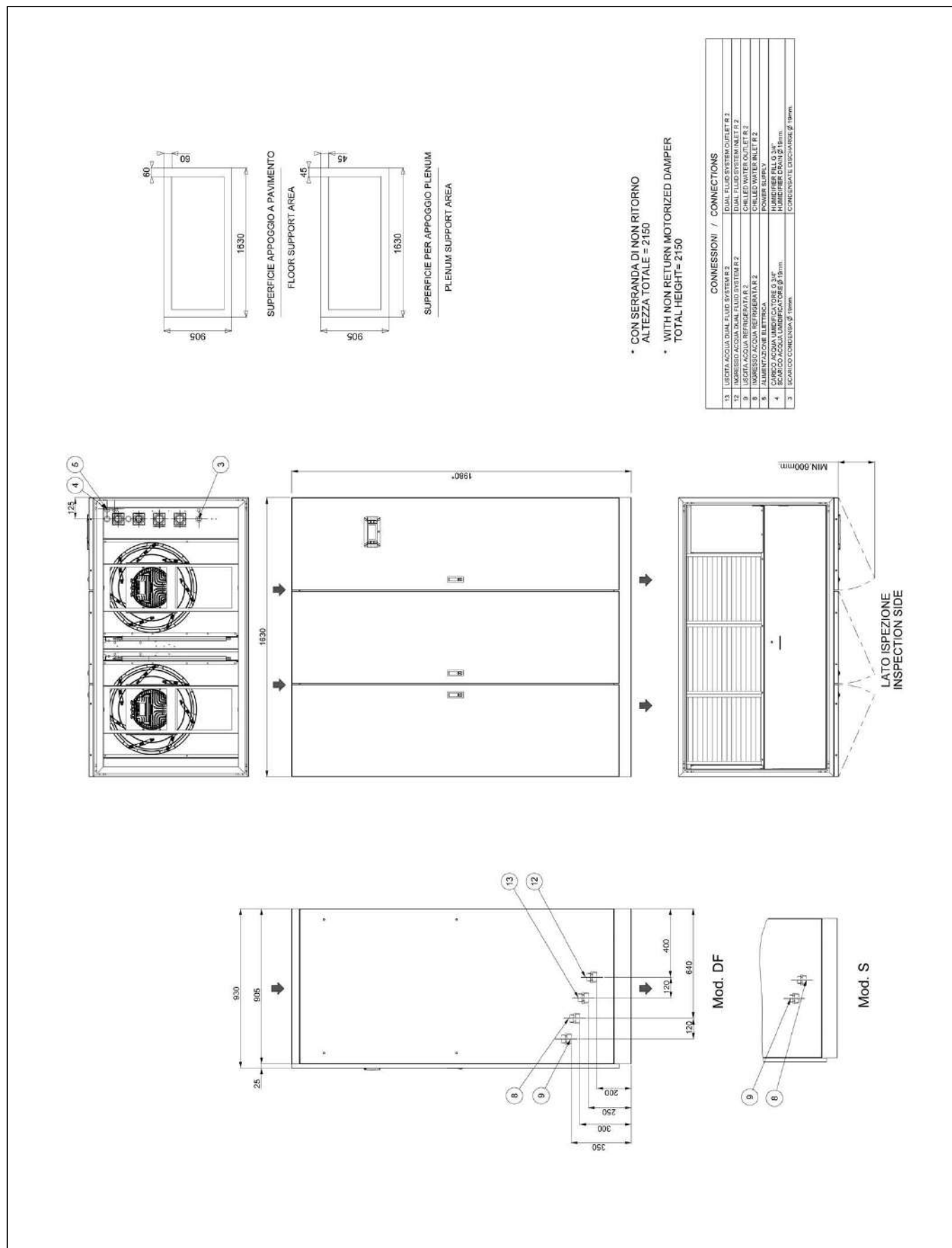

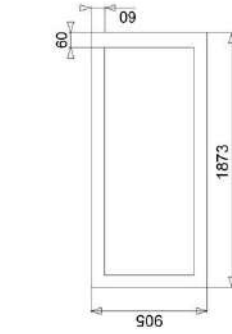

SUPERFICIE APOGGIO A PAVIMENTO
FLOOR SUPPORT AREA



SUPERFICIE PER APOGGIO PLENUM
PLENUM SUPPORT AREA

* CON SERRANDA DI NON RITORNO
ALTEZZA TOTALE = 2150
TOTAL HEIGHT= 2150

* WITH NON RETURN MOTORIZED DAMPER
TOTAL HEIGHT= 2150

CONNESSIONI / CONNECTIONS	
13	USCITA ACQUA DUAL FLUID SYSTEM R.2 / DUAL FLUID SYSTEM OUTLET R.2
12	IMGRESSO ACQUA DUAL FLUID SYSTEM R.2 / DUAL FLUID SYSTEM INLET R.2
9	USCITA ACQUA REFRIGERATA R.2 / CHILLED WATER OUTLET R.2
8	IMGRESSO ACQUA REFRIGERATA R.2 / CHILLED WATER INLET R.2
5	ALIMENTAZIONE ELETTRICA / POWER SUPPLY
4	SCARICO ACQUA UMIDIFICATORE & 3" / HUMIDIFIER DRAIN & 3" INCH.
3	SCARICO CONDENSATO & 1" INCH. / CONDENSATE DRAIN & 1" INCH.

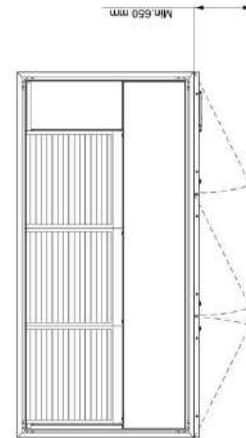
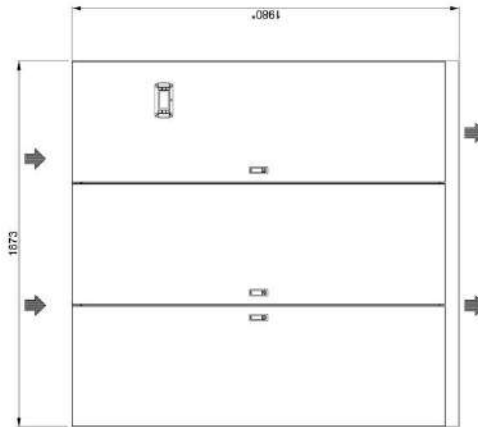
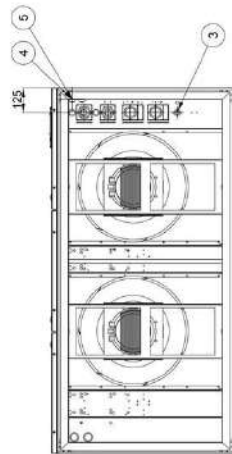

LATO ISPEZIONE
INSPECTION SIDE

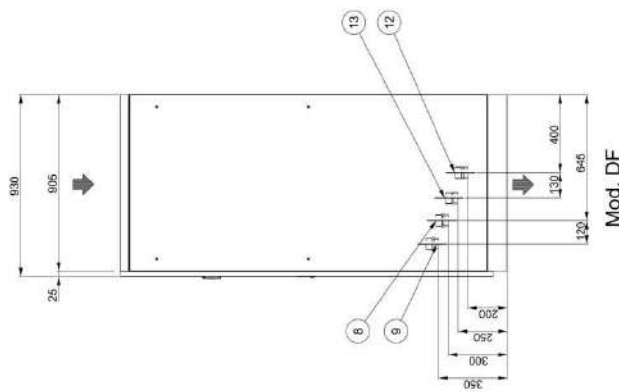

Mod. DF

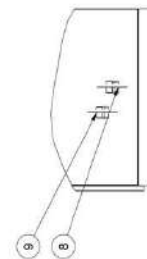

Mod. S

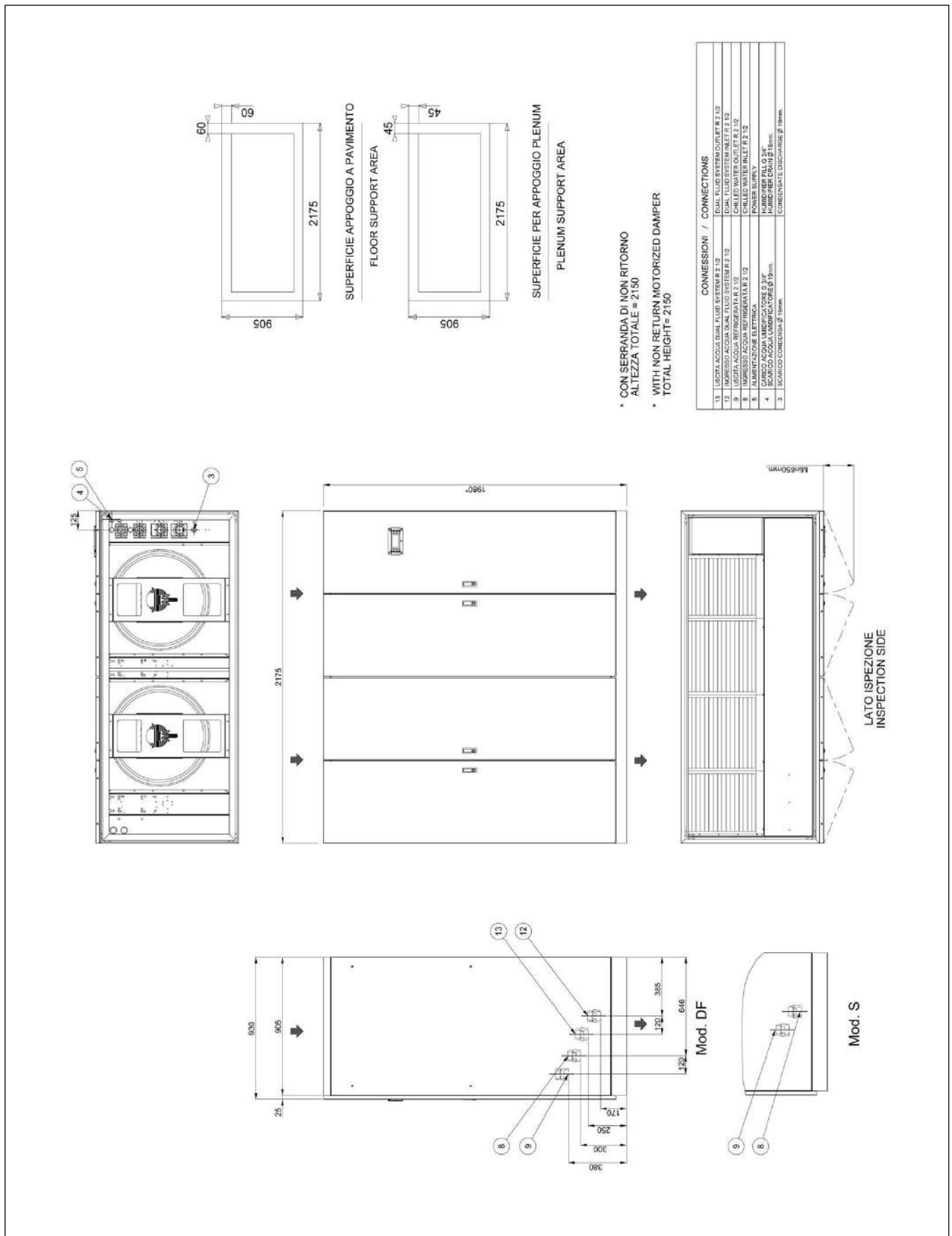

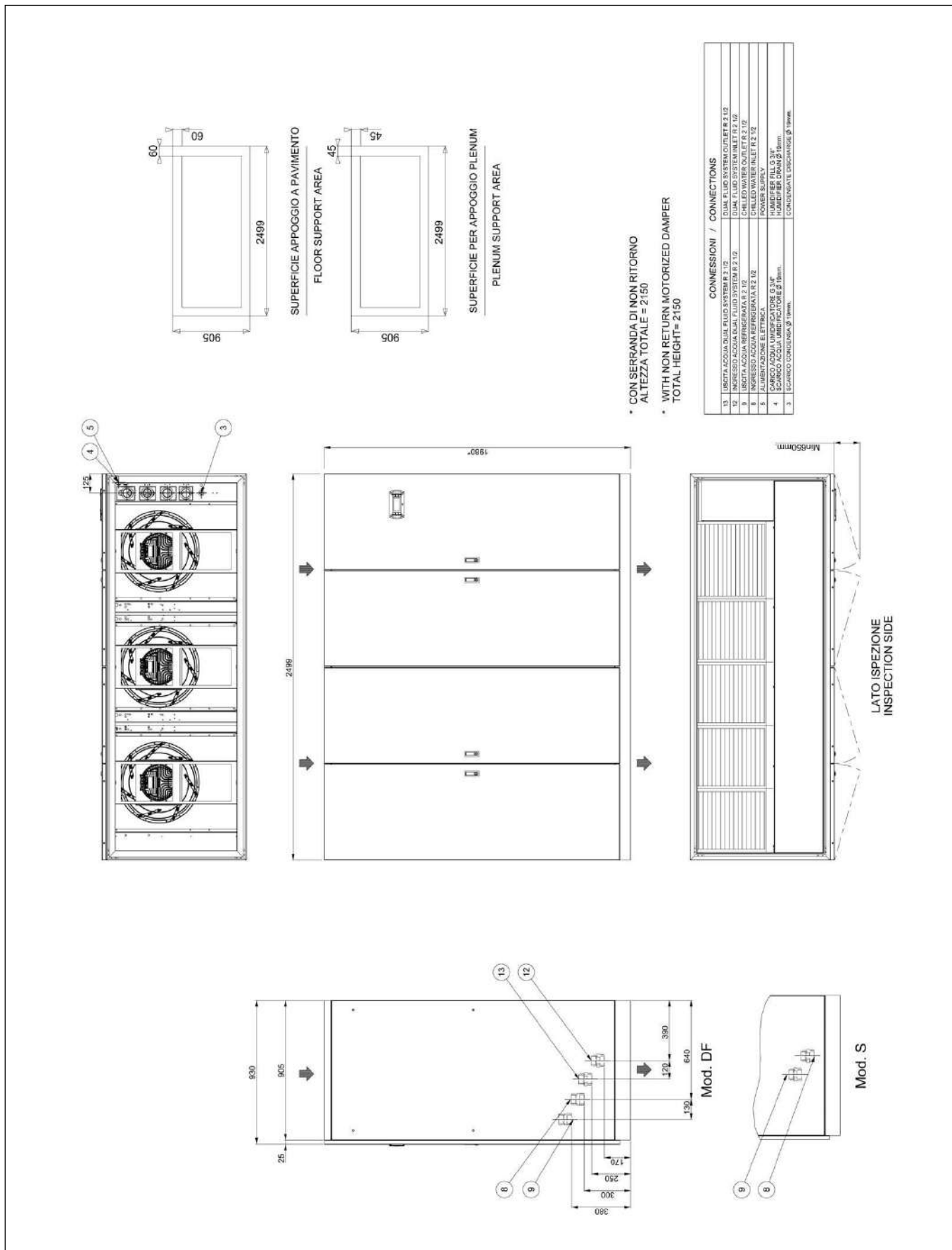

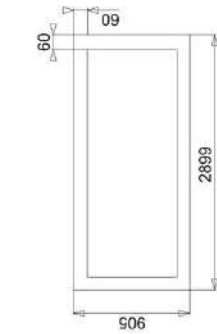

SUPERFICIE APOGGIO A PAVIMENTO
FLOOR SUPPORT AREA



SUPERFICIE PER APOGGIO PLENUM
PLENUM SUPPORT AREA

* CON SERRANDA DI NON RITORNO
ALTEZZA TOTALE = 2150

* WITH NON RETURN MOTORIZED DAMPER
TOTAL HEIGHT = 2150

CONNESSIONI / CONNECTIONS	
13	USCITA ACQUA DUAL FLUID SYSTEM R 3 DUAL FLUID SYSTEM OUTLET R 3
12	INGRESSO ACQUA DUAL FLUID SYSTEM R 3 DUAL FLUID SYSTEM INLET R 3
9	USCITA ACQUA REFRIGERATA R 3 CHILLED WATER OUTLET R 3
8	INGRESSO ACQUA REFRIGERATA R 3 CHILLED WATER INLET R 3
5	ALIMENTAZIONE ELETTRICA POWER SUPPLY
4	SCARICO ACQUA LAMBRICAZIONE 3/4" HUMIDITY DRAIN 3/4"
3	SCARICO CONDENSATE 1/2" CONDENSATE DISCHARGE 1/2"

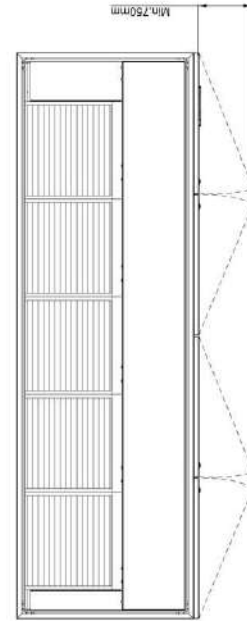
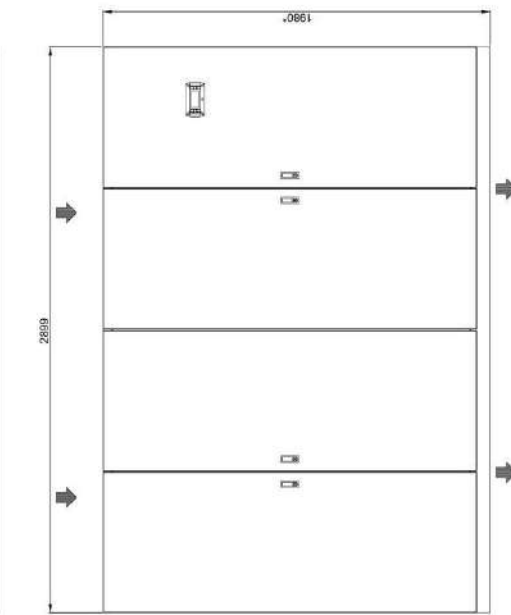
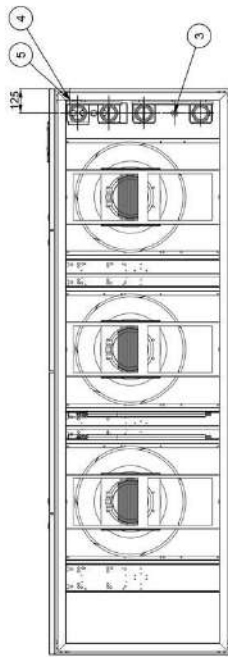

LATO ISPEZIONE
INSPECTION SIDE

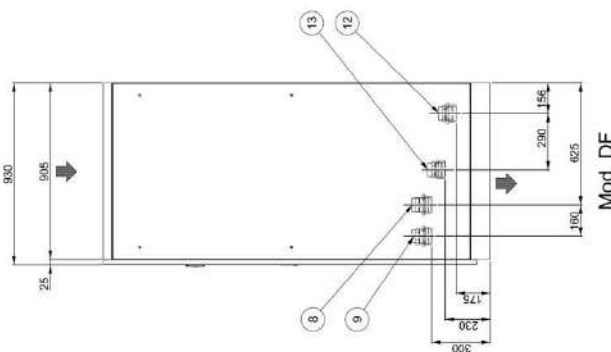

Mod. DF

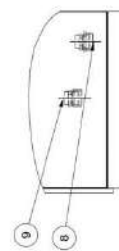

Mod. S

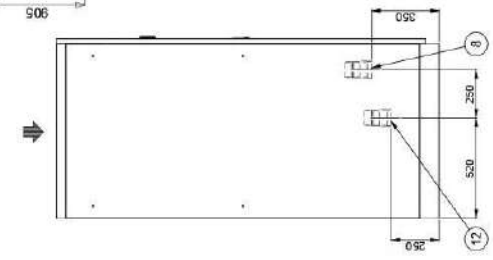
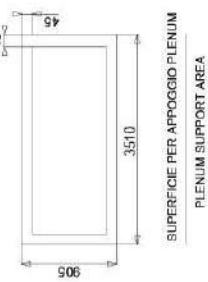
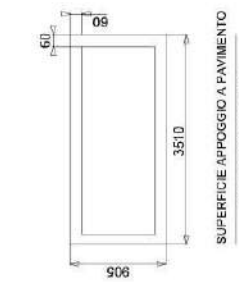

* CON SERRANDA DI NON RITORNO
ALTEZZA TOTALE = 2150

* WITH NON RETURN MOTORIZED DAMPER
TOTAL HEIGHT = 2150

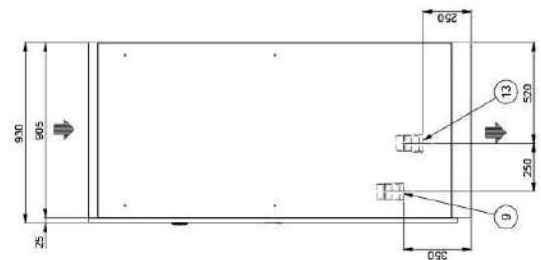
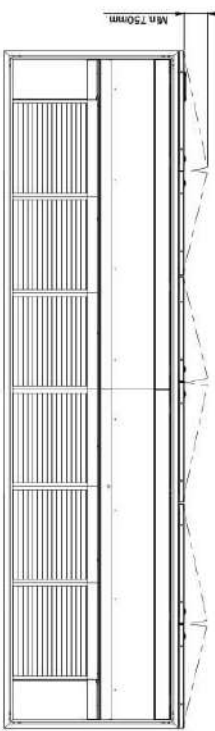
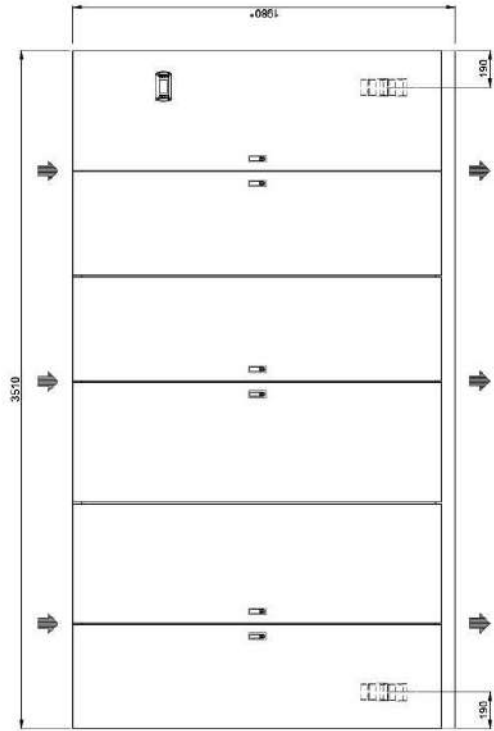
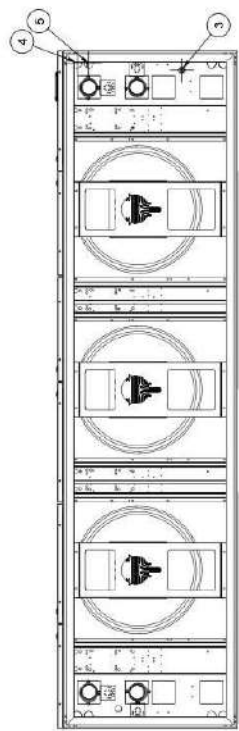

CONNESSIONI / CONNECTIONS

13	USCITA ACQUA DUAL FLUID SYSTEM QUANTO SCAMBIATO 3/3"	DUAL FLUID SYSTEM OUTLET COUPLING 3/3"
12	INGRESSO ACQUA DUAL FLUID SYSTEM QUANTO SCAMBIATO 3/3"	DUAL FLUID SYSTEM INLET COUPLING 3/3"
9	USCITA ACQUA REFRIGERATA QUANTO SCAMBIATO 3/3"	CHILLED WATER INLET COUPLING 3/3"
8	INGRESSO ACQUA REFRIGERATA QUANTO SCAMBIATO 3/3"	CHILLED WATER INLET COUPLING 3/3"
5	ALIMENTAZIONE ELETTRICA	POWER SUPPLY
4	SCARICO ACQUA UMIDIFICAZIONE 3/4"	HUMIDIFIER DRAIN 3/4"
3	SCARICO ACQUA UMIDIFICAZIONE 3/4"	HUMIDIFIER DRAIN 3/4"
2	SCARICO CONDENSATI 3/4"	CONDENSATE DRAINAGE 3/4"

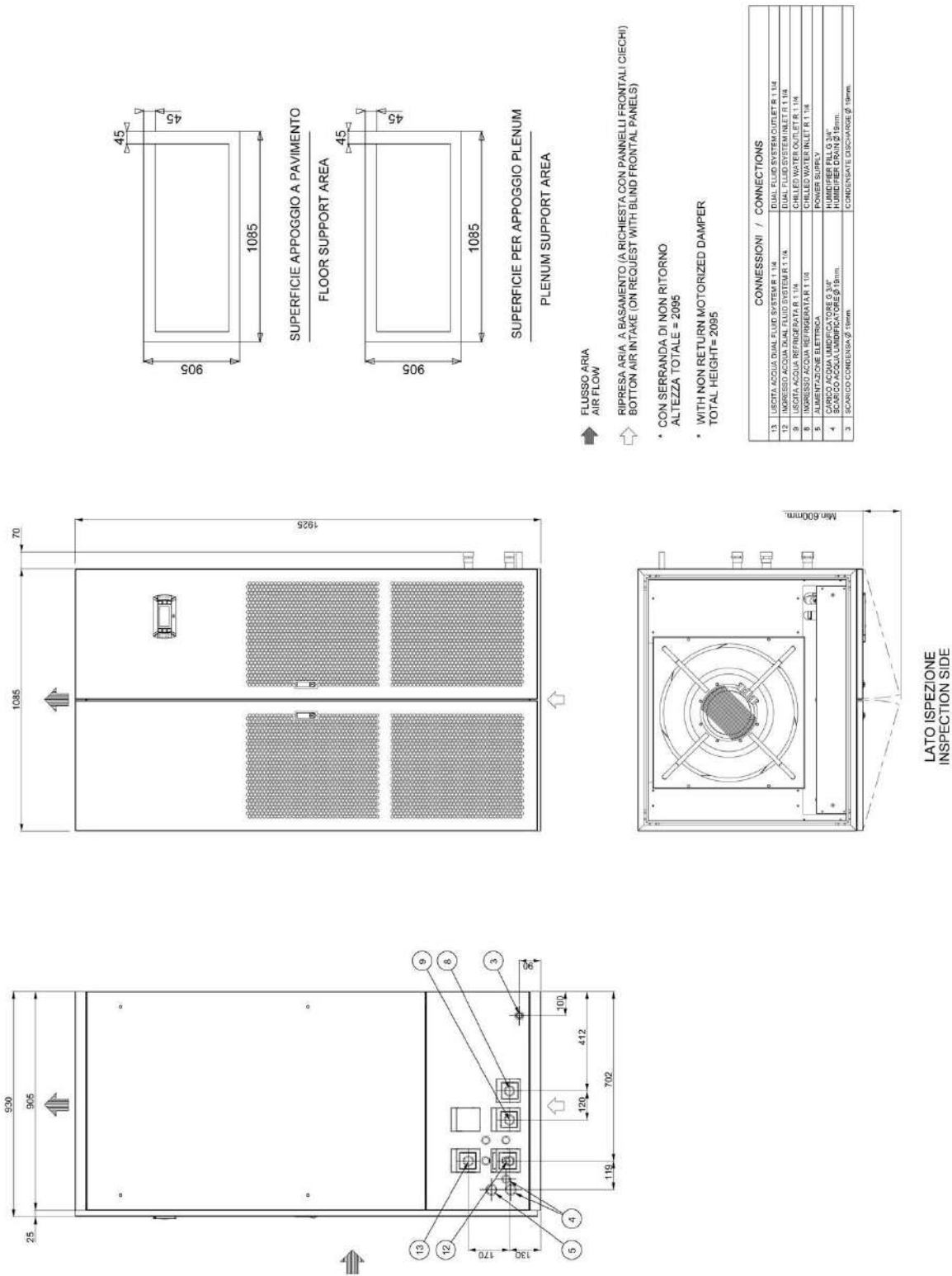

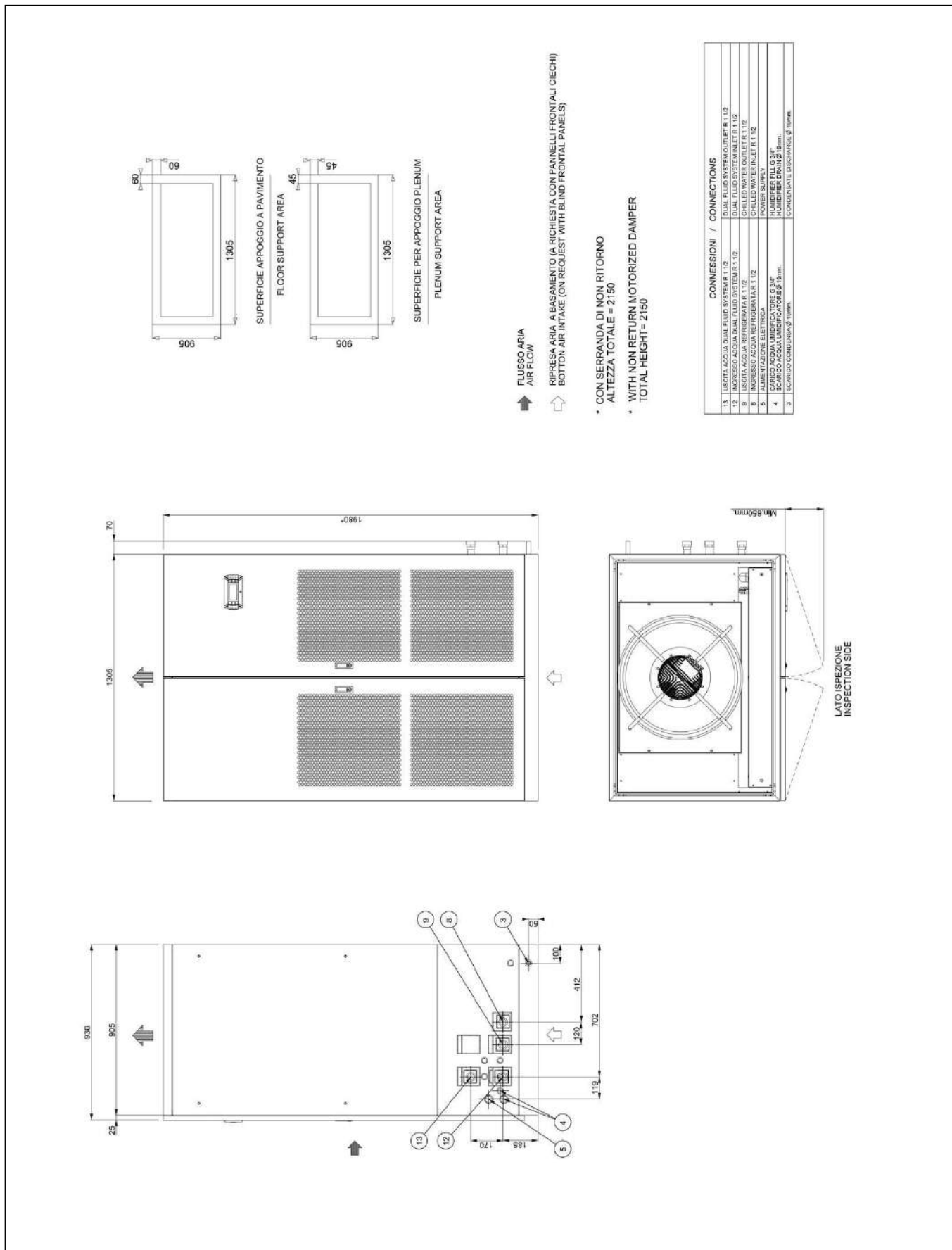

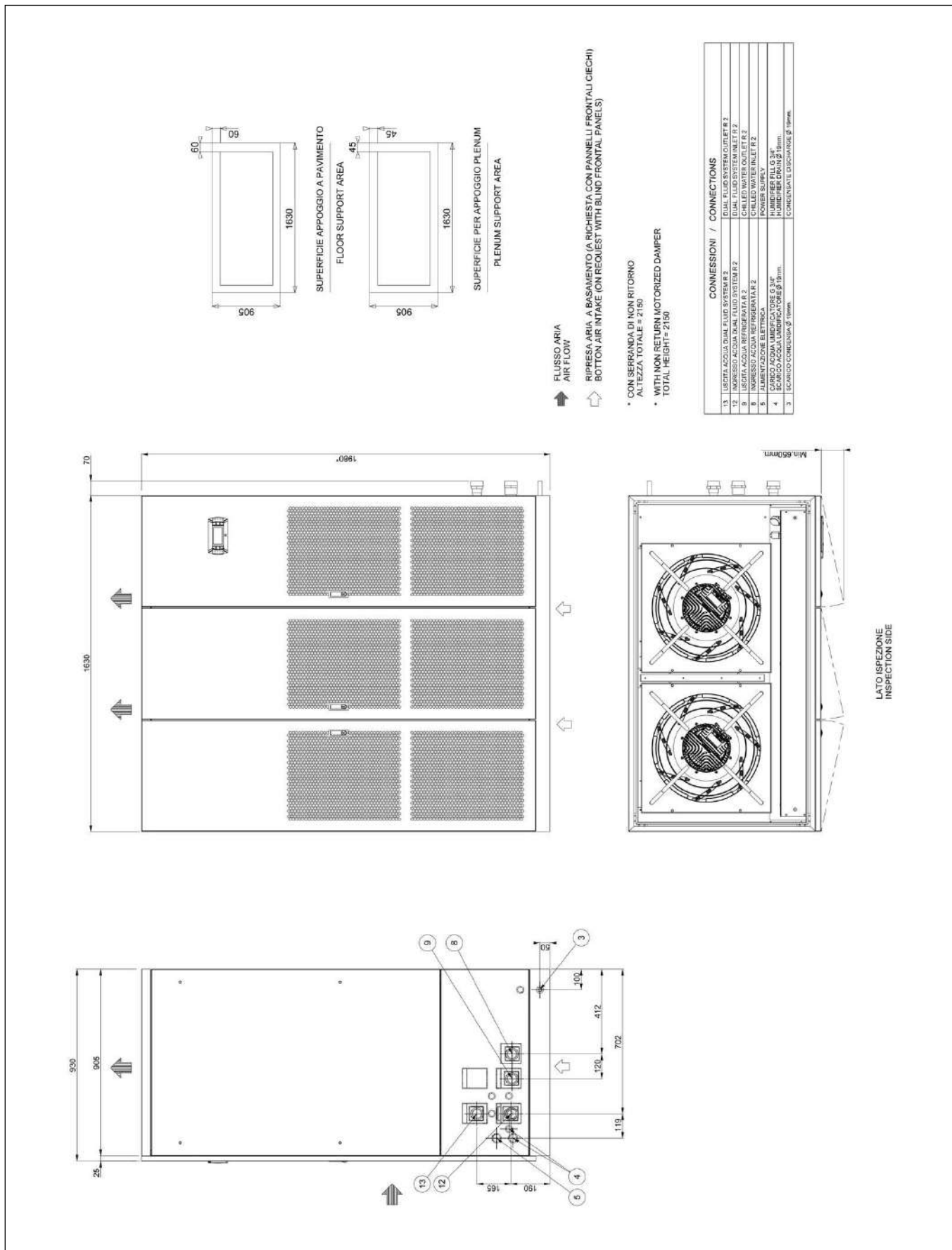

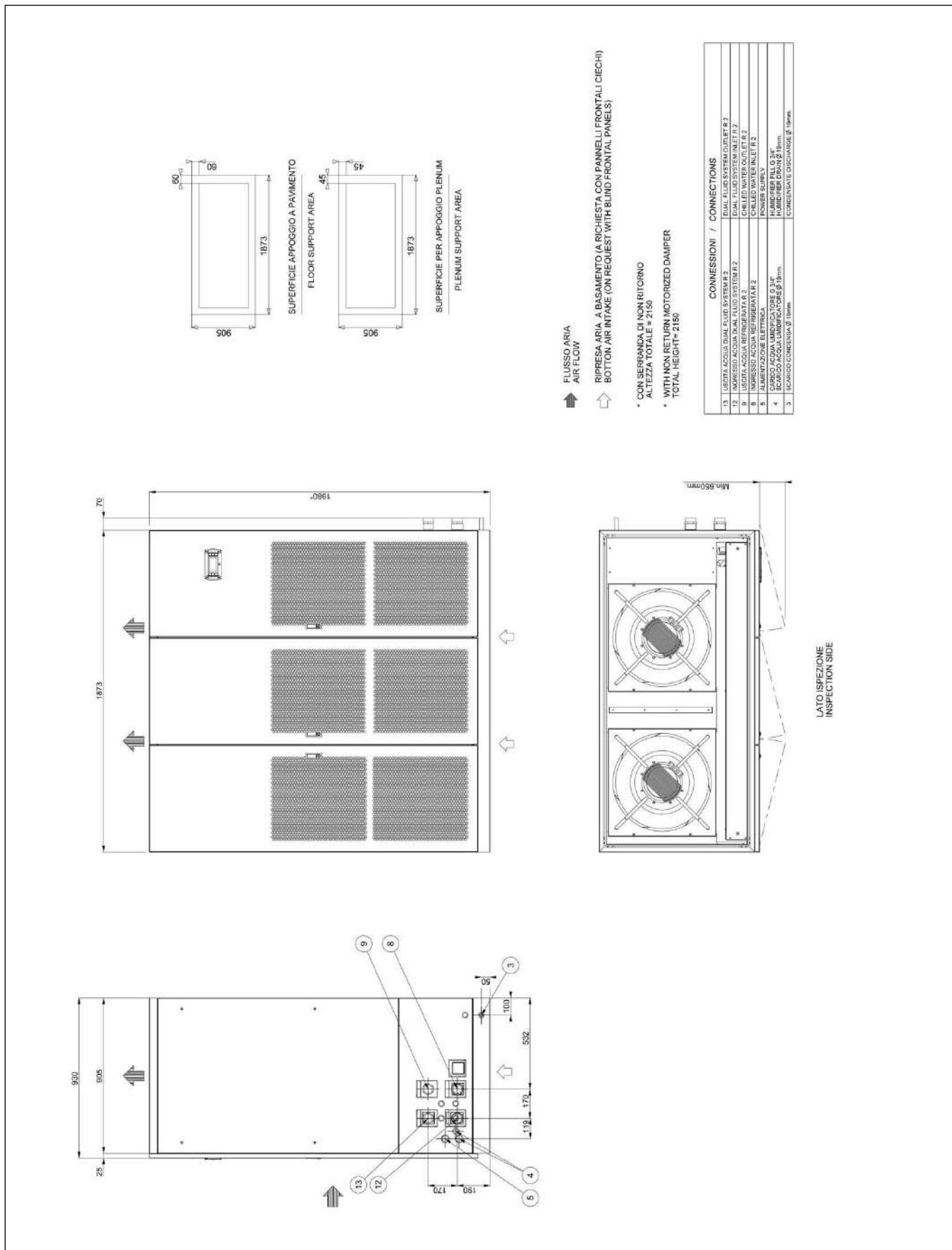

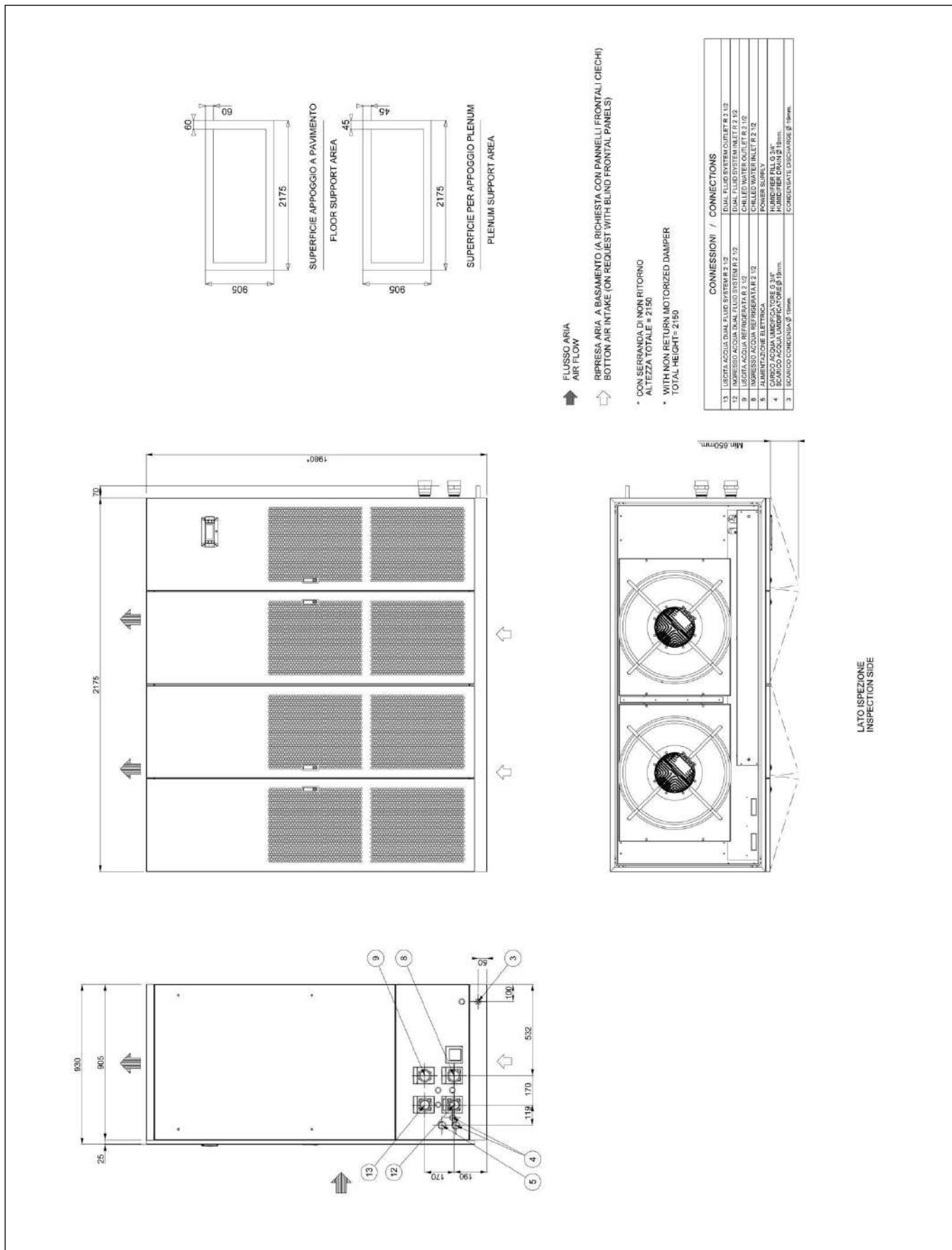

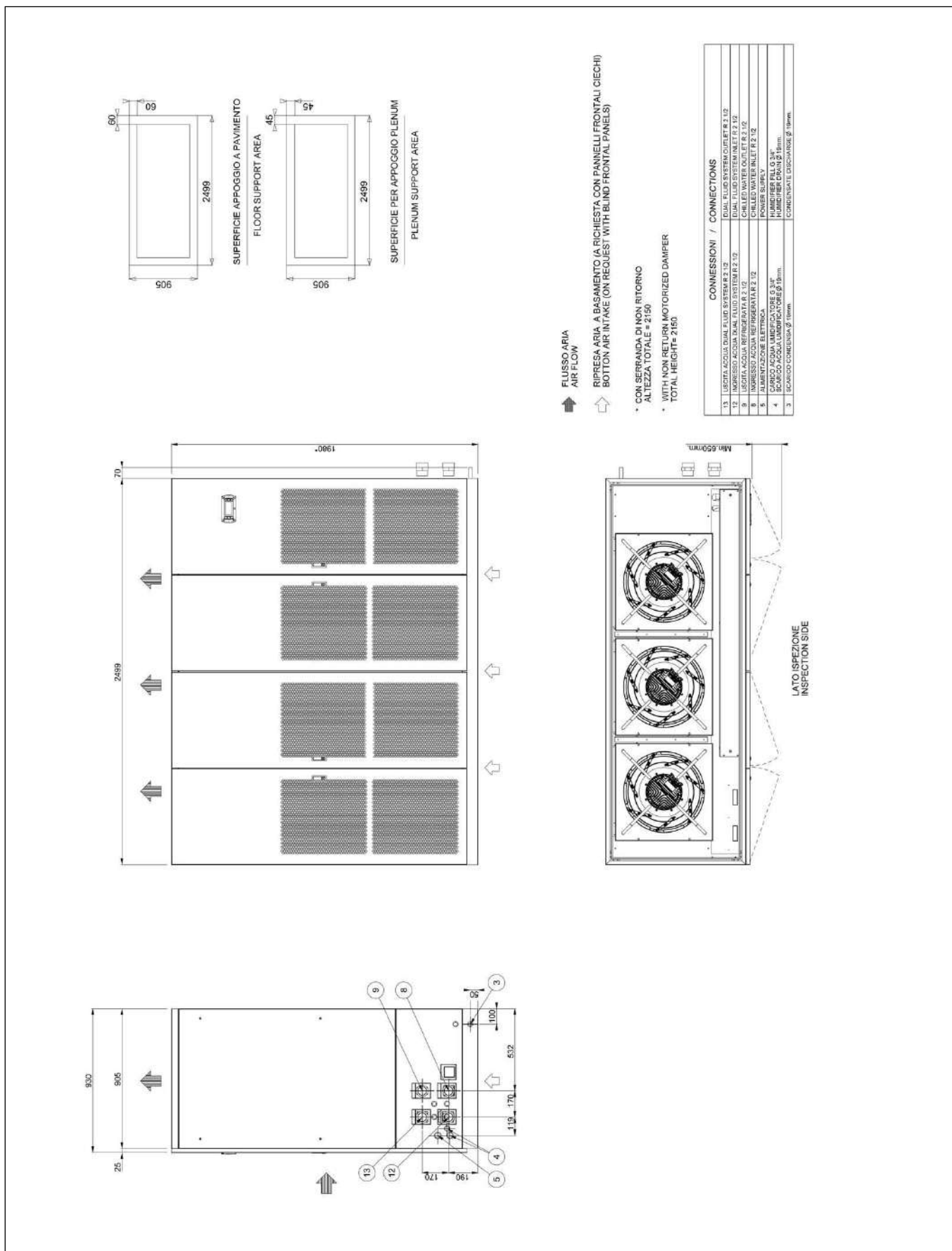

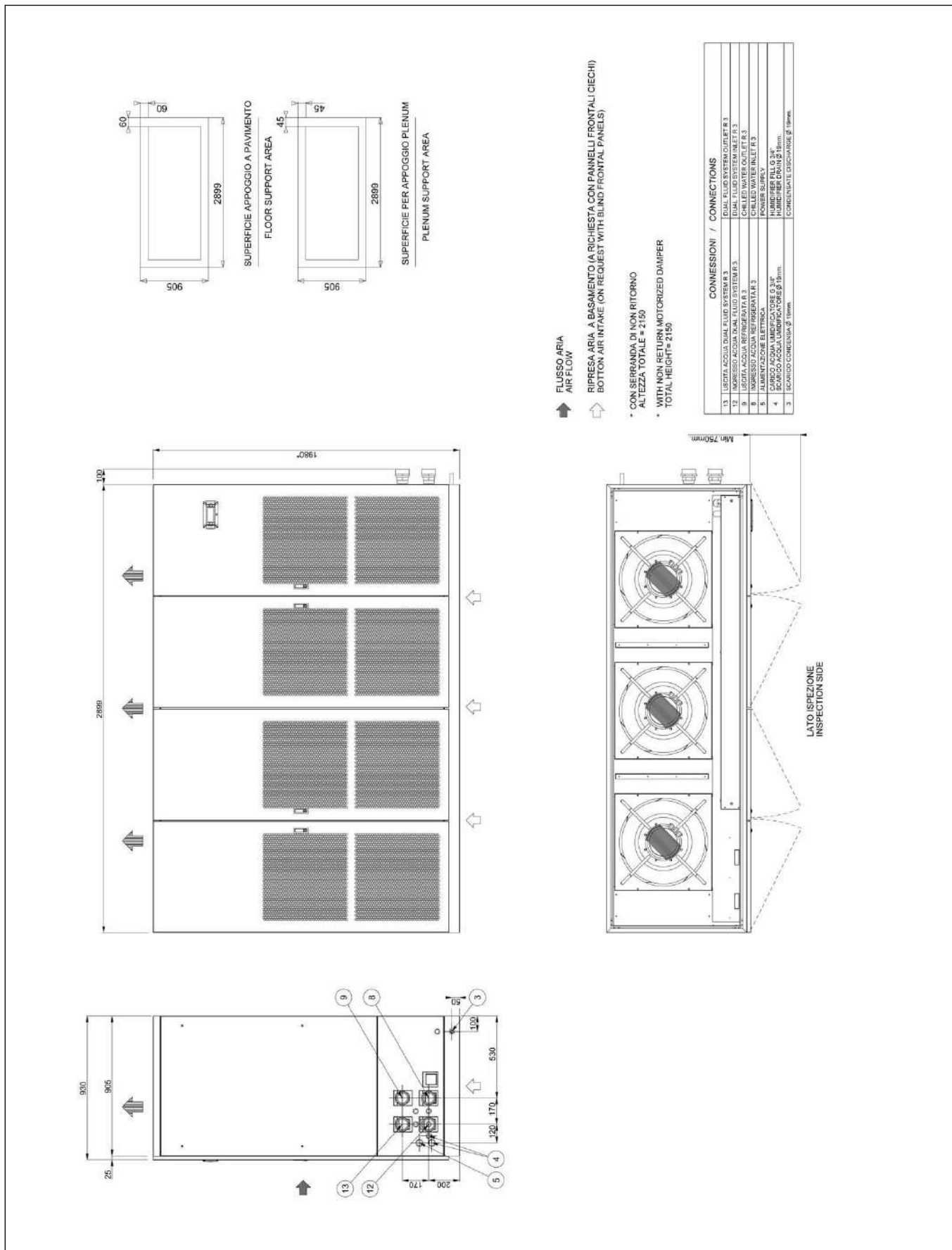

HOLE IN THE RAISED FLOOR FOR DOWNFLOW VERSION

HOLE IN THE RAISED FLOOR WITHOUT FLOOR STAND

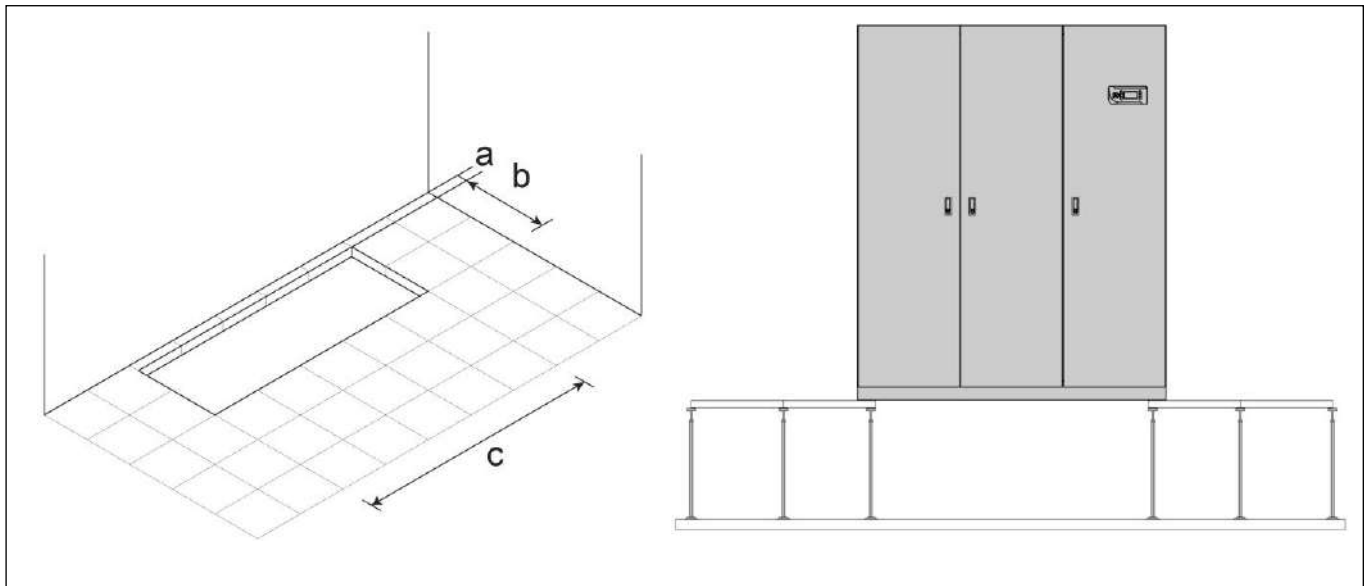

Foresee a hole in the floor with the following dimensions:

SIZE		E3P	E4	E5	E6	E7	E8	E9	E10
a	mm	95	110	110	110	110	110	110	110
b	mm	815	785	785	785	785	785	785	785
c	mm	995	1185	1510	1755	2055	2380	2780	3390

HOLE IN THE RAISED FLOOR WITH FLOOR STAND (OPTION)

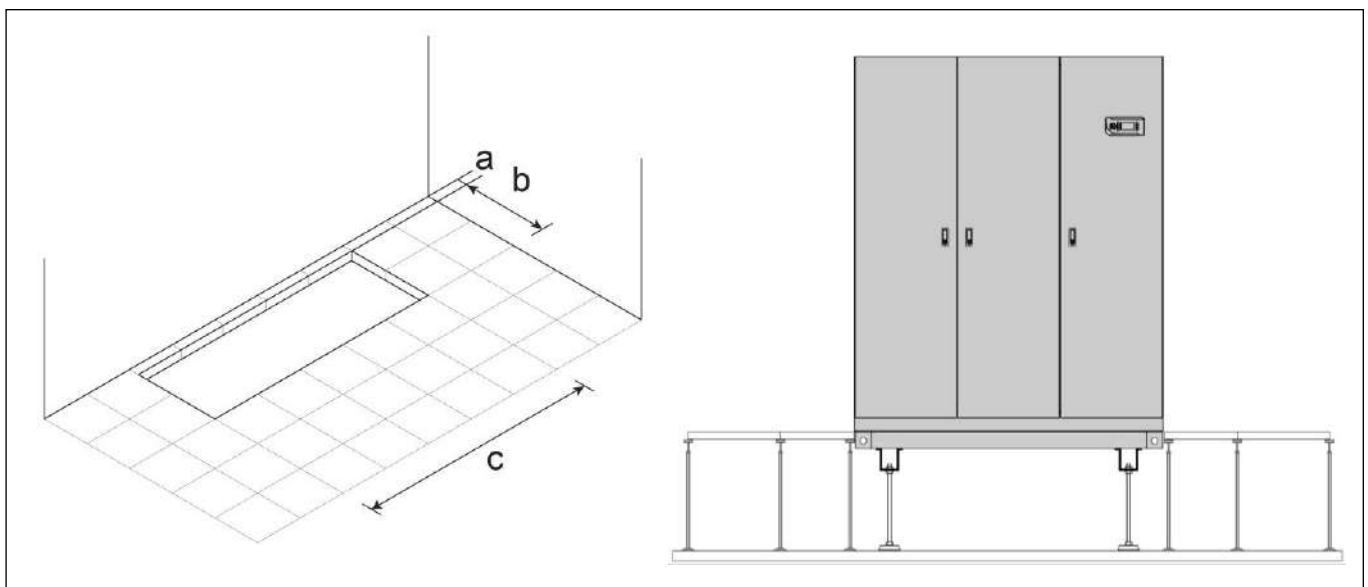

Foresee a hole in the floor with the following dimensions:

SIZE		E3P	E4	E5	E6	E7	E8	E9	E10
a	mm	50	50	50	50	50	50	50	50
b	mm	925	925	925	925	925	925	925	925
c	mm	1105	1325	1650	1895	2195	2520	2920	3530

EXAMPLE FOR MACHINES NOISE EMISSION CALCULATION

UNDER MACHINE WITH DUCT ON AIR INTAKE

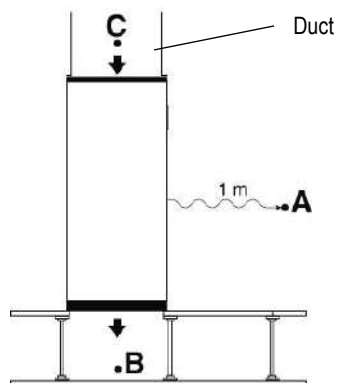

- Lp A = Front side Under catalogue value
- Lp B = Air delivery Under catalogue value
- Lp C = Air intake Under catalogue value
- The points B and C do not influence the point A

UNDER MACHINE WITH PLENUM ON AIR DELIVERY

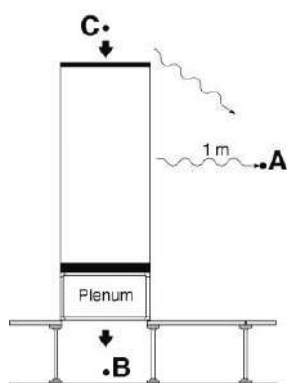

- Lp A = Front side Under catalogue value
- Lp B = Air delivery Under catalogue value – plenum noise reduction
- Lp C = Air intake Under catalogue value
- $Lp A+C = 10 \log_{10} \left(10^{\frac{LpA}{10}} + 10^{\frac{LpC}{10}} \right)$
- The point B do not influence the point A

UNDER MACHINE WITH PLENUM ON AIR INTAKE

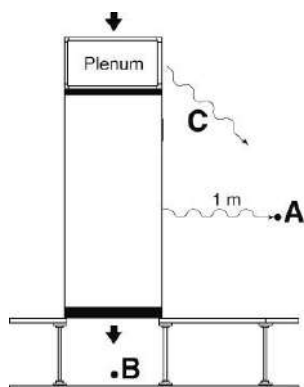

- Lp A = Front side Under catalogue value
- Lp B = Air delivery Under catalogue value
- Lp C = Air intake Under catalogue value – plenum noise reduction
- $Lp A+C = 10 \log_{10} \left(10^{\frac{LpA}{10}} + 10^{\frac{LpC}{10}} \right)$
- The point B do not influence the point A

OVER MACHINE WITH DUCT

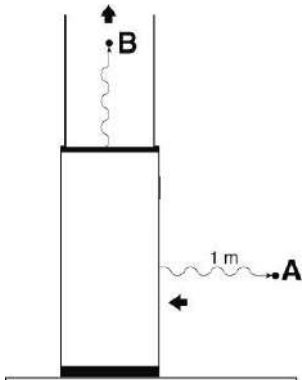

- Lp A = Air intake Over catalogue value
- Lp B = Air delivery Over catalogue value
- The point B do not influence the point A

EXAMPLE FOR MACHINES NOISE EMISSION CALCULATION

OVER MACHINE WITH PLENUM ON AIR DELIVERY

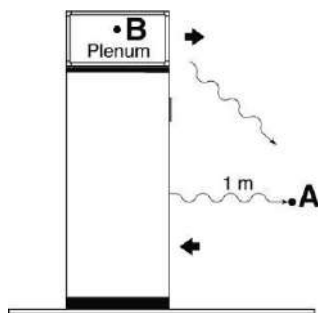

Lp A = Air intake Over catalogue value

Lp B = Air delivery Over catalogue value – plenum noise reduction

$$Lp A+B = 10 \log_{10} \left(10^{\frac{LpA}{10}} + 10^{\frac{LpC}{10}} \right)$$

OVER MACHINE WITH DUCT AND PLENUM ON AIR DELIVERY

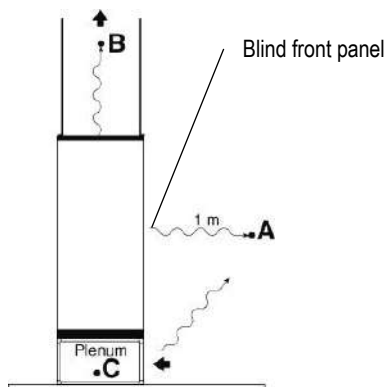

Lp A = Front side Over catalogue value

Lp B = Air delivery Over catalogue value

Lp C = Lp A + 6dB(A) – plenum noise reduction

$$Lp A+C = 10 \log_{10} \left(10^{\frac{LpA}{10}} + 10^{\frac{LpC}{10}} \right)$$

The point B do not influence the point A+C

OVER MACHINE WITH DUCT AND PLENUM ON AIR DELIVERY

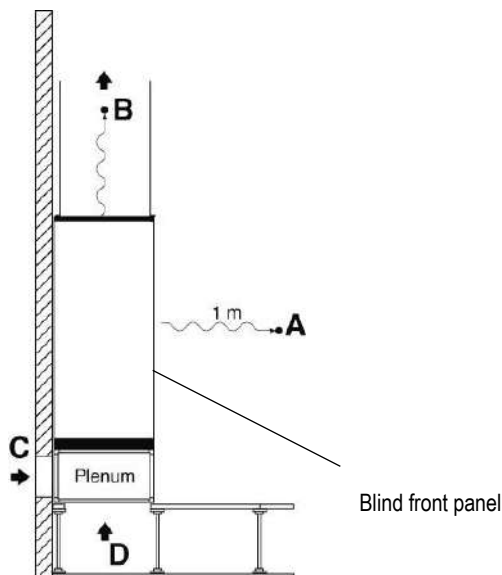

Lp A = Front side Over catalogue value

Lp B = Air delivery Over catalogue value

Lp C = Lp D = Lp A + 6 dB(A) – plenum noise reduction

The points B, C and D do not influence the point A

IMPORTANT

The declared noise levels are intended in free field conditions.

The noise pressure level of an installed unit is affected by the room acoustic characteristics.

Please consider an average noise increase of +4/+6 dB(A).

VALVE PRESSURE DROP CALCULATION AS FUNCTION OF WATER FLOW RATE

Flow coefficient k_v defines the water flow (between 5°C and 40°C) expressed in m³/h that cross a valve with a pressure drop of 1bar (100kPa).

With this data is possible to calculate the localized pressure drop as function of the water flow rate.

$$\Delta P = (Q / k_v)^2$$

ΔP (bar) = localized pressure drops of valve.

Q (m³/h) = water flow rate – it varies according to the desired operating condition.

k_v (m³/h) = valve flow coefficient.

The formula allows to calculate the value of the localized pressure drop (in bar).

The pressure drops values showed on the documentation are supplied in kPa.

Is possible to change from one unit to another through the following conversion.

$$1 \text{ bar} = 100\text{kPa}$$

CALCULATION EXAMPLE OF 2-WAY VALVE FOR BY-PASS PRESSURE DROP IN FUNCTION OF CHILLED WATER COIL WATER FLOW RATE

Model 120 E8 – CHILLED WATER COIL

Example at nominal conditions. Characteristics referred to entering air at 24°C-50%RH with chilled water temperature 7-12°C - 0% glycol.

Water flow rate: 20,9 m³/h

Valve flow coefficient k_v : 25 m³/h

$$\text{2-way valve for by-pass pressure drop: } \Delta P = (Q / k_v)^2 = (20,9 / 25)^2 = 0,698 \text{ (bar)} * 100 \text{ (kPa / bar)} = 69,8 \text{ kPa}$$

AIR FILTERS REPLACEMENT FOR UNDER VERSION MACHINES

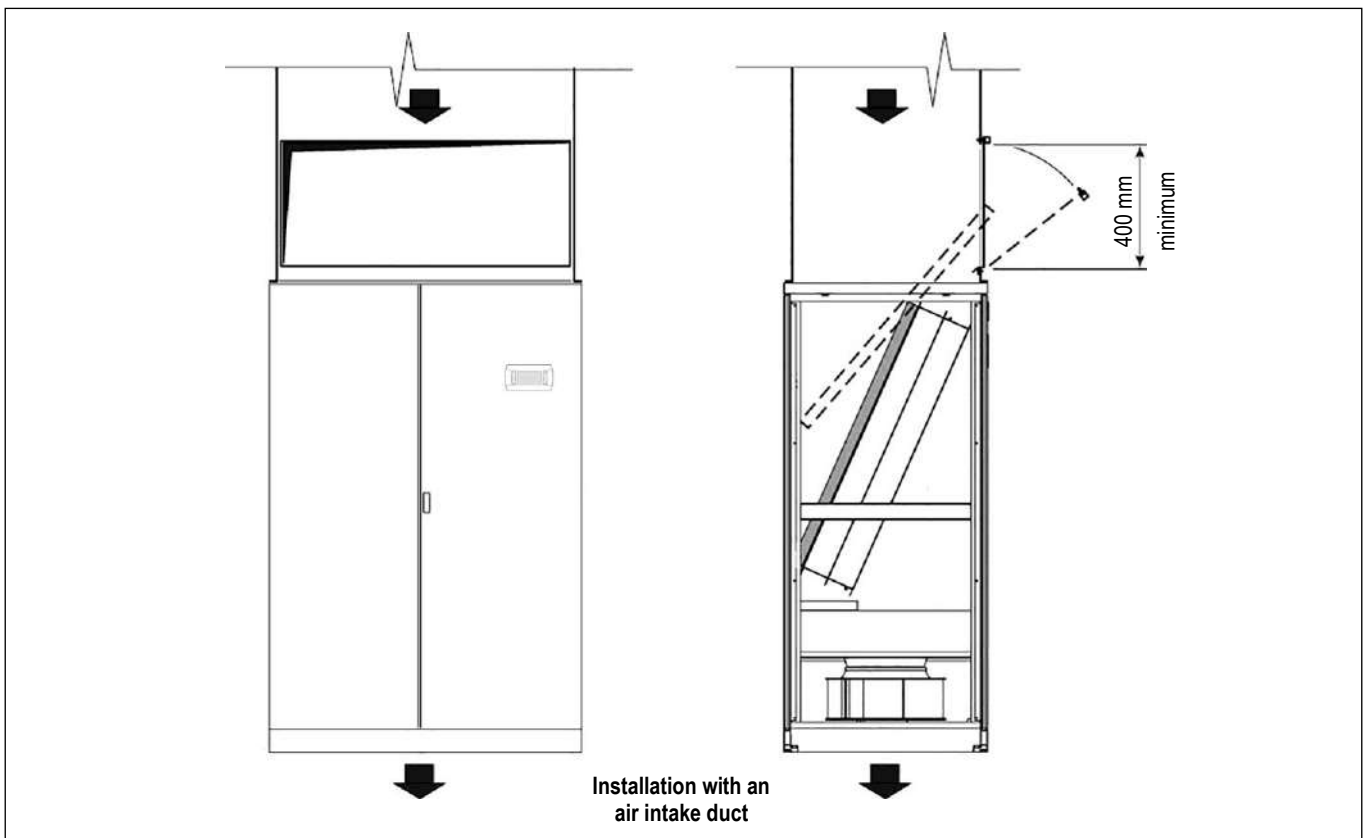
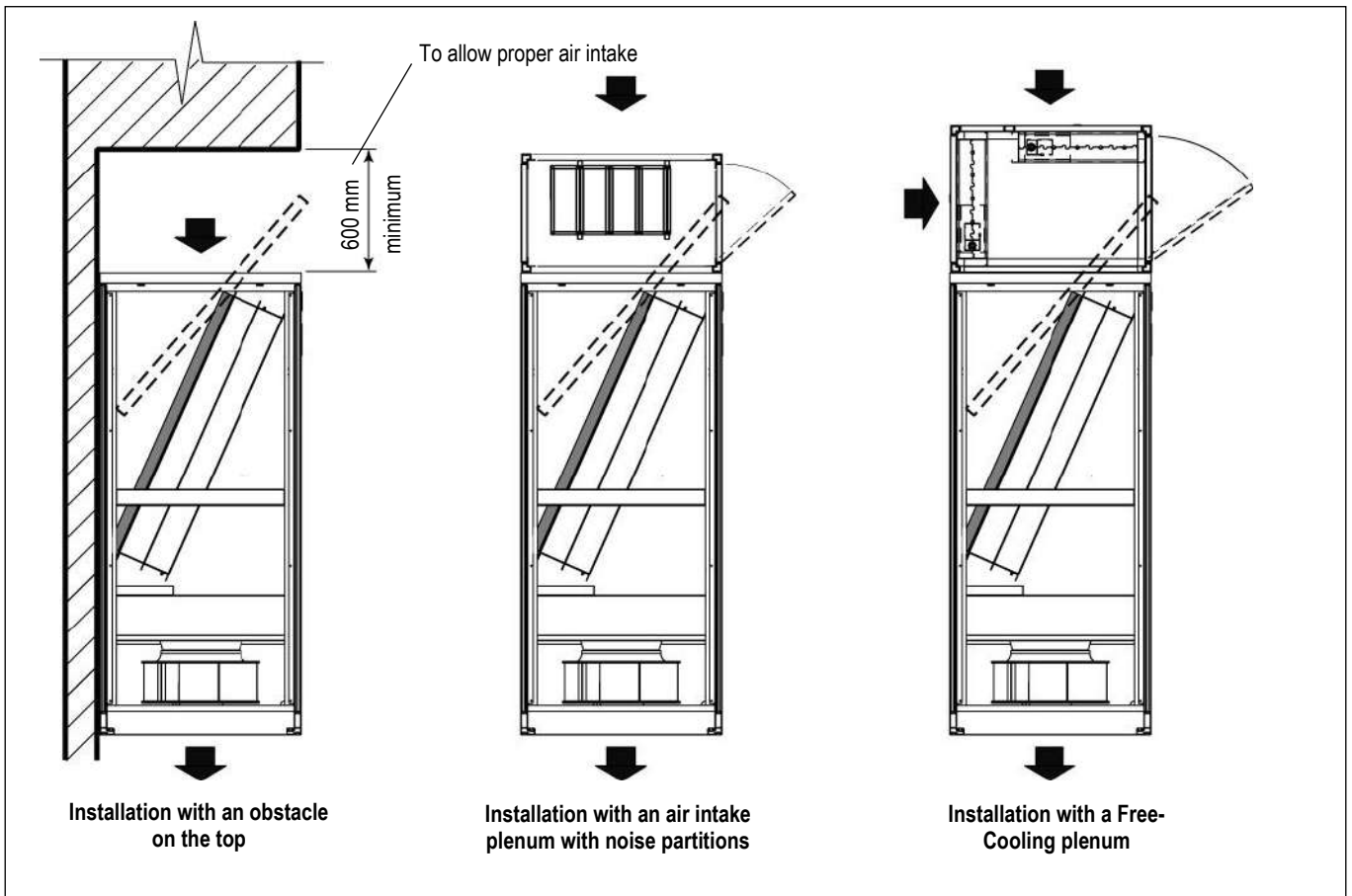

SHIPMENT: PACKING DIMENSIONS

Values referred to basic machine. The presence of some accessories increases the weight of machine.

The machines are shipped on pallet and covered with shrink wrap.
On request packing on pallet covered with shrink wrap and wooden cage.

STANDARD PACKING DIMENSIONS

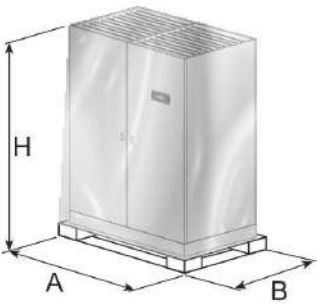

Size	A (mm)	B (mm)	H (mm)
E3P	1200	1050	2080
E4	1400	1050	2130
E5	1750	1050	2130
E6	2000	1050	2130
E7	2280	1050	2130
E8	2650	1050	2130
E9	3000	1050	2130
E10	3600	1050	2130

OPTIONAL 9973: WOODEN CAGE PACKING DIMENSIONS

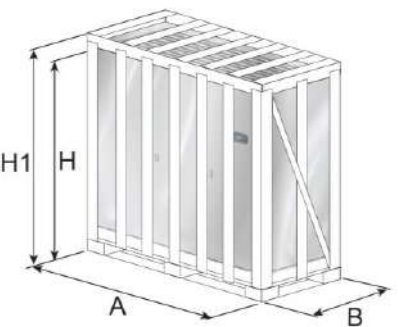

Size	A (mm)	B (mm)	H (mm)	H1 (*) (mm)
E3P	1240	1090	2150	2350
E4	1440	1090	2200	2350
E5	1790	1090	2200	2350
E6	2040	1090	2200	2350
E7	2320	1090	2200	2350
E8	2690	1090	2200	2350
E9	3040	1090	2200	2350
E10	3640	1090	2200	2350

H1 (*) = Packing height with optional A531 on/off damper

SHIPMENT: SHIPPING WEIGHT

STANDARD PACKING

Model	045	053	072	081	100	120	138	160	215	
Size	E3P	E4	E5	E6	E7	E8	E9	E10	E10	
Weight UNDER	kg	354	408,5	506	571,5	635	714,5	814,5	973	1043
Weight OVER	kg	346	374,5	464	523,5	581	652,5	740,5	--	--

OPTIONAL 9973: WOODEN CAGE PACKING

Model	045	053	072	081	100	120	138	160	215	
Size	E3P	E4	E5	E6	E7	E8	E9	E10	E10	
Weight UNDER	kg	386	444,5	542	615,5	687	764,5	872,5	1031	1101
Weight UNDER (1)	kg	425	488,5	597	678,5	759	847,5	970,5	1154	1224
Weight OVER	kg	378	410,5	500	567,5	633	702,5	798,5	--	--
Weight OVER (1)	kg	417	454,5	555	630,5	705	788,5	896,5	--	--

(1) Machine with optional A531 on/off damper

SHIPMENT: OPTIONALS PACKING DIMENSIONS AND SHIPPING WEIGHT

- P011 - EMPTY PLENUM
- P012 - EMPTY PLENUM CL.A1
- P031 - EMPTY INTAKE PLENUM
- P032 - EMPTY INTAKE PLENUM CL.A1
- P013 - PLENUM + 3 GRILLES
- P014 - PLENUM + 3 GRILLES CL.A1
- P015 - SILENCED PLENUM
- P016 - SILENCED PLENUM + 1 GRILLE
- P017 - PLENUM + FILTER EPM2.5 50%
- P018 - PLENUM + FILTER EPM1 50%
- P019 - PLENUM + FILTER EPM1 85%

The plenums are shipped on pallet and covered with shrink wrap.

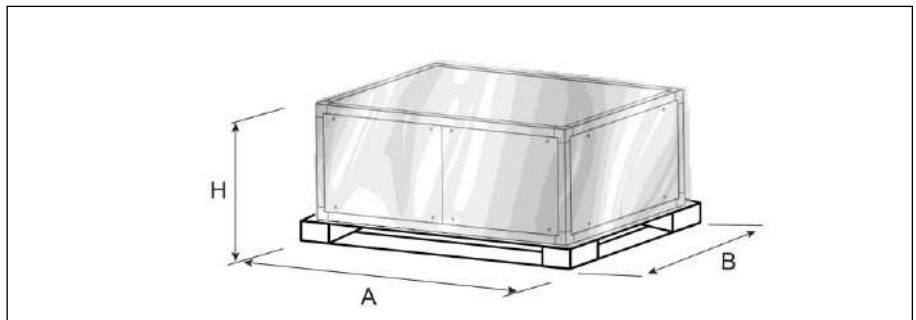

Size		E3P	E4	E5	E6	E7	E8	E9	E10
DIMENSIONS									
A	mm	1200	1400	1750	2000	2280	2650	3000	3600
B	mm	1050	1050	1050	1050	1050	1050	1050	1050
H	mm	630	630	630	630	630	630	630	630
SHIPPING WEIGHT									
P011 - Empty plenum "O" / "U"	kg	44	53	69	78	88	105	122	146
P012 - Empty plenum CL.A1 "O" / "U"	kg	52	62	79	89	100	119	137	167
P031 - Empty intake plenum "O" / "U"	kg	44	53	69	78	88	105	122	146
P032 - Empty intake plenum CL.A1 "O" / "U"	kg	52	62	79	89	100	119	137	167
P013 - Plenum + 3 grilles "O" / "U"	kg	56	68	79	96	106	135	152	192
P014 - Plenum + 3 grilles CL.A1 "O" / "U"	kg	63	77	90	107	122	151	170	212
P015 - Silenced plenum "O" / "U"	kg	56	68	81	98	113	130	152	182
P016 - Silenced plenum + 1 grille "O" / "U"	kg	64	88	101	111	126	155	182	212
P017 - P018 - P019 - Plenum + filter "O" / "U"	kg	52	68	84	98	118	135	152	182

"O" Over / "U" Under

P034: INTAKE FREE-COOLING PLENUM

The plenums are shipped on pallet and covered with shrink wrap.

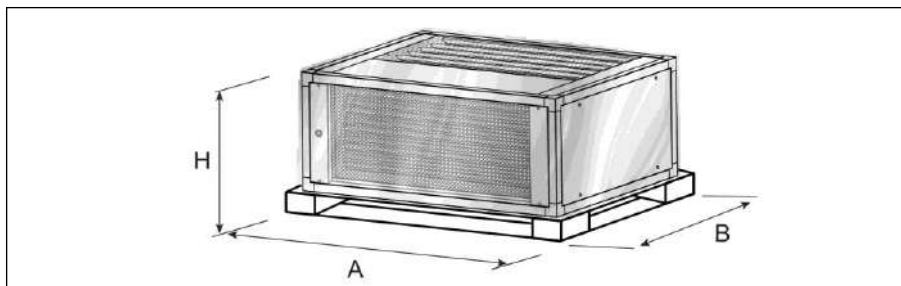

Size		E3P	E4	E5	E6	E7	E8	E9	E10
DIMENSIONS									
A	mm	1200	1400	1750	2000	2280	2650	3000	3600
B	mm	1050	1050	1050	1050	1050	1050	1050	1050
H	mm	630	750	750	750	750	750	750	750
SHIPPING WEIGHT									
P034 - Intake free-cooling plenum "U"	kg	62	76	90	111	128	155	182	217
P034 - Intake free-cooling plenum "O"	kg	62	76	90	111	128	155	182	217

"O" Over / "U" Under

P041 / P042 / P043: SUPPORT FRAME

The support frames are shipped on pallet and covered with shrink wrap.

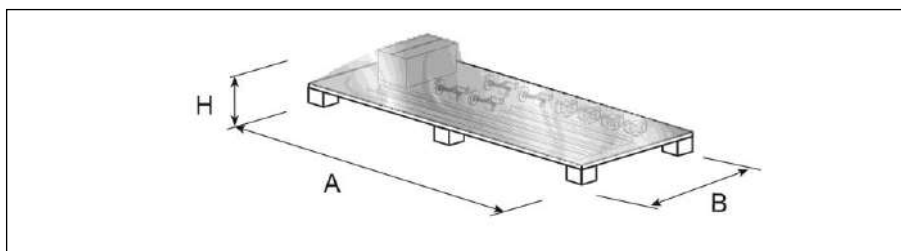

Size		E3P	E4	E5	E6	E7	E8	E9	E10
DIMENSIONS									
A	mm	1200	1400	1750	2000	2280	2650	3000	3600
B	mm	900	900	900	900	900	900	900	900
H	mm	500	500	500	500	500	500	500	500
SHIPPING WEIGHT									
	kg	30	37	40	44	47	49	53	58

P113 / P114: DUAL POWER SUPPLY KIT / DUAL POWER SUPPLY KIT+OPTIONAL

The optional are shipped in a cardboard box.

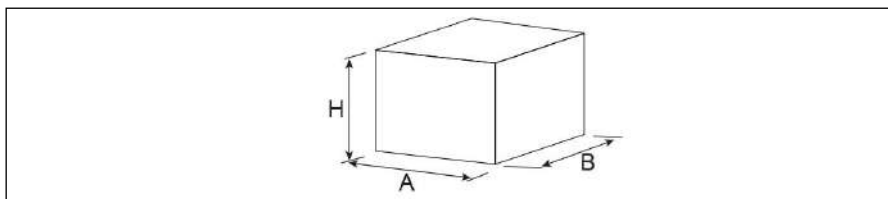

Size		E3P	E4	E5	E6	E7	E8	E9	E10
DIMENSIONS									
A	mm	400	400	--	--	--	--	--	--
B	mm	400	400	--	--	--	--	--	--
H	mm	210	210	--	--	--	--	--	--
SHIPPING WEIGHT									
	kg	12	12	--	--	--	--	--	--



for a greener tomorrow

Eco Changes is the Mitsubishi Electric Group's environmental statement, and expresses the Group's stance on environmental management. Through a wide range of businesses, we are helping contribute to the realization of a sustainable society.



MITSUBISHI ELECTRIC HYDRONICS & IT COOLING SYSTEMS S.p.A.

Via Caduti di Cefalonia, 1 - 36061 Bassano del Grappa (VI) Italy
Ph. (+39) 0424 509 500 • Fax (+39) 0424 509 509
www.melcohit.com

