

Data Book

T_wAV3_0621_EN

w-AV3

4 - 25 kW

Air conditioners for IT Cooling for chilled water feeding.

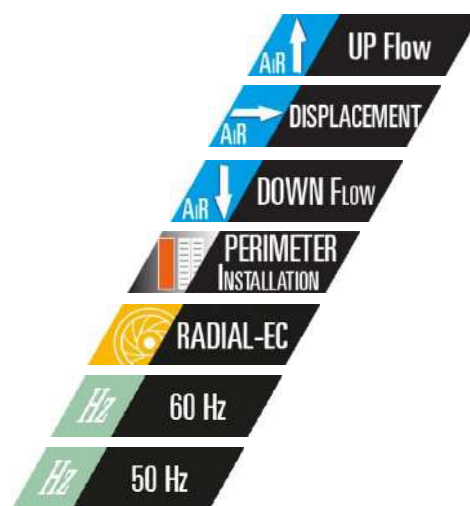

The pictures of the units are indicative and may vary depending on the model

- For small Data Room
- Bottom, top, or front air delivery
- Plug-fan with EC electric motors
- Air suction temperature up to 45°C
- Total front accessibility
- LAN connection up to 15 units

INDEX

CERTIFICATIONS	4
GENERAL CHARACTERISTICS	4
THE SERIES	7
PRODUCT FEATURES AND BENEFITS	8
MODEL IDENTIFICATION	8
STORING TEMPERATURE	8
WORKING LIMITS	9
LIMIT OF CHILLED WATER TEMPERATURE AT THE UNIT'S INLET	9
MAIN COMPONENTS	10
OPTIONAL ACCESSORIES	11
TECHNICAL DATA – UNDER / OVER VERSION	13
TECHNICAL DATA – DISPLACEMENT VERSION	14
ACTIVE REDUNDANCY	15
HYDRAULIC CIRCUIT	15
2-WAY BALL VALVE FOR CHILLED WATER FLOW CONTROL	16
WATER QUALITY OF THE HYDRAULIC CIRCUITS	16
ANTIFREEZE MIXTURES	17
ACOUSTIC DATA	17
ELECTRICAL DATA	18
MICROPROCESSOR CONTROL SYSTEM	20
OPTIONAL ACCESSORIES: P122 - BOTTOM AIR INTAKE+BLIND PANELS	22
OPTIONAL ACCESSORIES: B264 – BACK AIR INTAKE+BLIND PANELS	22
OPTIONAL ACCESSORIES: A547 / A548 - CONSTANT FLOW / CONSTANT PREVALENCE	23
OPTIONAL ACCESSORIES: B792 – 400/3+N/50 POWER SUPPLY	23
OPTIONAL ACCESSORIES: B794 – 230/1/60 POWER SUPPLY	23
OPTIONAL ACCESSORIES: B795 – 230/3/60 POWER SUPPLY	23
OPTIONAL ACCESSORIES: B796 – 380/3+N/60 POWER SUPPLY	23
OPTIONAL ACCESSORIES: B798 – 460/3+N/60 POWER SUPPLY	23
OPTIONAL ACCESSORIES: P091 – BACKUP MODULE CONTROLLER	23
OPTIONAL ACCESSORIES: 383 – NUMBERED WIRINGS + UK REQUESTS	24
OPTIONAL ACCESSORIES: A471 – SERIAL CARD RS485	24
OPTIONAL ACCESSORIES: A472 – SERIAL CARD RS232	24
OPTIONAL ACCESSORIES: A473 – ETHERNET CARD	24
OPTIONAL ACCESSORIES: A474 – SERIAL CARD LON	24
OPTIONAL ACCESSORIES: B811 - AIR FLOW LOSS ALARM	24
OPTIONAL ACCESSORIES: A381 - DRAIN PUMP	25
OPTIONAL ACCESSORIES: A491 - WATER LEAKAGE DETECTOR	26
OPTIONAL ACCESSORIES: A492 – WATER LEAKAGE DETECTOR + ADDITIONAL SENSOR	26
OPTIONAL ACCESSORIES: A501 - CLOGGED FILTERS	26
OPTIONAL ACCESSORIES: A511 – SMOKE DETECTOR	26
OPTIONAL ACCESSORIES: A521 – FIRE DETECTOR	26
OPTIONAL ACCESSORIES: 5891 – CONTROL UNIT VIA KIPLINK	27
OPTIONAL ACCESSORIES: A35B – GRAPHIC DISPLAY “EVOLUTION TOUCH”	28
OPTIONAL ACCESSORIES: A352 - NO DISPLAY	28
OPTIONAL ACCESSORIES: A822 – ADAPTIVE SET-POINT	29
OPTIONAL ACCESSORIES: P141 – ANALOGUE SET-POINT COMPENSATION	29
OPTIONAL ACCESSORIES: A842 - NETWORK ANALYZER	29
OPTIONAL ACCESSORIES: A812 – FREE-COOLING DIRECT CONTROL	29
OPTIONAL ACCESSORIES: A791 – AIR TEMPERATURE CONTROL ON AIR RETURN	29
OPTIONAL ACCESSORIES: B803 – 0-10V 3-WAY VALVE	30
OPTIONAL ACCESSORIES: B807 - EPIV 2-WAY VALVE	31
OPTIONAL ACCESSORIES: P131 – HOT WATER COIL + 2WAY VALVE	32

OPTIONAL ACCESSORIES: A431 - ELECTRIC HEATERS.....	34
OPTIONAL ACCESSORIES: 4301 – STEAM HUMIDIFIER.....	35
OPTIONAL ACCESSORIES: P051 - DEHUMIDIFICATION.....	37
OPTIONAL ACCESSORIES: P161 – T/RH AIR INTAKE SENSOR.....	37
OPTIONAL ACCESSORIES: 4666 – EXTERNAL AIR PROBE	37
OPTIONAL ACCESSORIES: P071 / P072 / P073 / P074 - REMOTE T/RH PROBE.....	37
OPTIONAL ACCESSORIES: P113 - DUAL POWER SUPPLY.....	37
OPTIONAL ACCESSORIES: P084 – EPM ₁₀ 50% AIR FILTERS	38
OPTIONAL ACCESSORIES: A532 – DAMPER WITH SPRING RETURN	39
OPTIONAL ACCESSORIES: P011 ... P034 - SUPPLY / INTAKE AIR PLENUM.....	40
OPTIONAL ACCESSORIES: P034 – INTAKE FREE-COOLING PLENUM.....	45
OPTIONAL ACCESSORIES: P041 / P042 / P043 - SUPPORT FRAME	47
OPTIONAL ACCESSORIES: A272 – CL.A1 (EN13501-1) INSULATION	47
OPTIONAL ACCESSORIES: P151 – LOWERED DISPLAY FOR UNDER.....	48
OPTIONAL ACCESSORIES: P101 - ANTI-SEISMIC FIXING KIT.....	48
OPTIONAL ACCESSORIES: T500000310 / 311 - CONDENSATE TRAY (ONLY UNDER VERSION)	49
OPTIONAL ACCESSORIES: LM8300023 / 54 - UNIT BIND BRACKET.....	50
MACHINE DRAWINGS	51
HOLE IN THE RAISED FLOOR FOR DOWNFLOW VERSION	57
EXAMPLE FOR MACHINES NOISE EMISSION CALCULATION.....	58
SHIPMENT: PACKING DIMENSIONS.....	60
SHIPMENT: SHIPPING WEIGHT	61
SHIPMENT: OPTIONALS PACKING DIMENSIONS AND SHIPPING WEIGHT.....	61
VALVE PRESSURE DROP CALCULATION AS FUNCTION OF WATER FLOW RATE.....	63

Liability disclaimer

The present publication is drawn up by of information only and does not constitute an offer binding upon Mitsubishi Electric Hydronics & IT Cooling Systems S.p.A. Mitsubishi Electric Hydronics & IT Cooling Systems S.p.A. has compiled the content of this publication to the best of its knowledge.

The data contained herein are subject to change without notice. Mitsubishi Electric Hydronics & IT Cooling Systems S.p.A. explicitly rejects any liability for any direct or indirect damage, in the broadest sense, arising from or related to the use and/or interpretation of this publication. All content is copyrighted by Mitsubishi Electric Hydronics & IT Cooling Systems S.p.A.

CERTIFICATIONS



CE MARKING



RoHS II compliant 2011/65/EU

GENERAL CHARACTERISTICS



w-AV3

w-AV3

Chilled water unit for the close control air conditioning in small Data Centre, UPS rooms, Batteries rooms, Distribution rooms and in all areas of the Data Center that need a service of air conditioning.

The "state of the art" in components granting high reliability and close control in temperature following the trend of the thermal load.

The constructive solutions and the internal lay-out allow high application flexibility and the frontal access to the main components for the inspection and routine maintenance.

Final assembly on all machines before shipment including running test, reading and monitoring of operating parameters, alarms simulation and visual check.

Plant example:

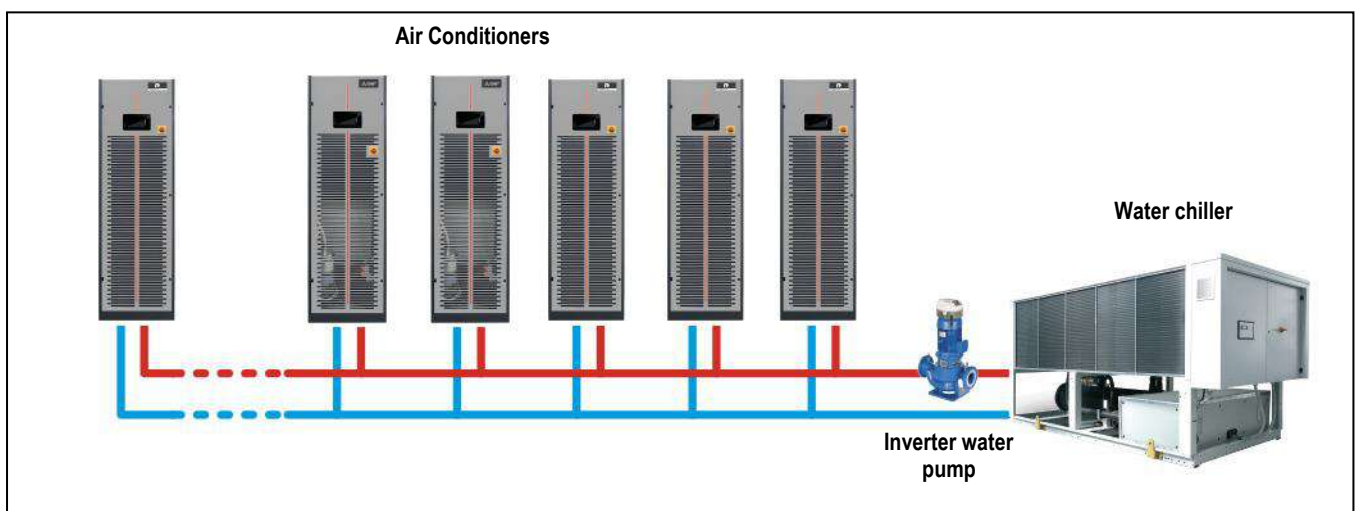



The extreme flexibility allows top installation that adapts perfectly to every requirement of the plant with 3 types of air delivery:

DOWNFLOW AIR DELIVERY (U - UNDER)

Application suitable for server racks with vented front and rear doors.

Typical installation is on the perimeter. the units are placed along the walls of the room.

The air distribution is from the bottom by means of the plenum between the building floor and the raised floor. This solution is usually applied in hi-tech. air conditioning and it is most favourable when load is uniformly distributed in all areas of the room.

The air distribution is achieved by special tiles placed in front of the racks row, forming cold aisle for air diffusion.

On the rear of the racks is expelled the hot air then aspirated by the unit.

For an optimal installation is advisable to provide the cold aisle containment.

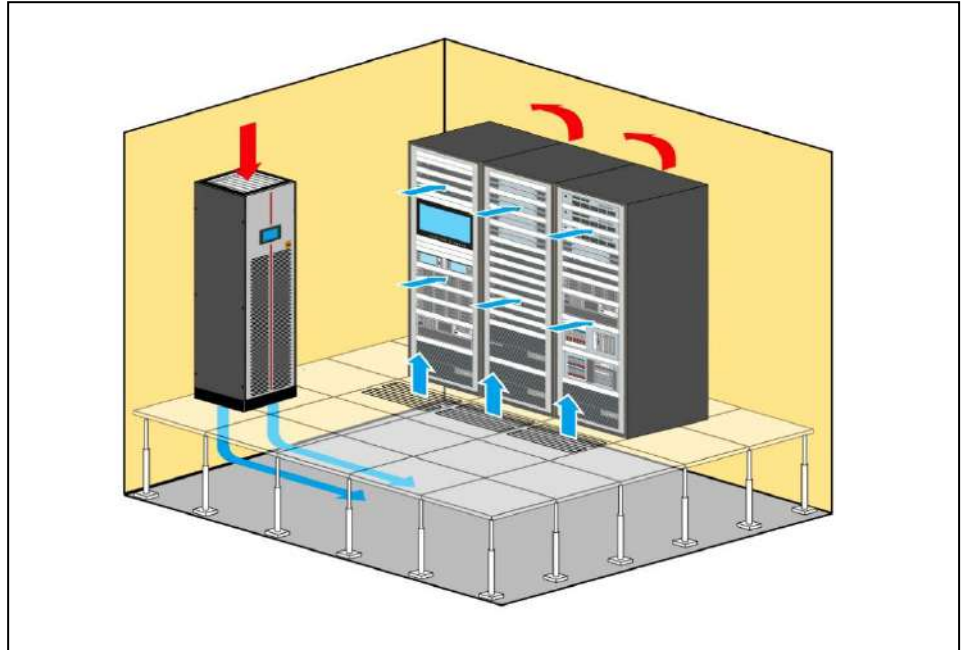

UPFLOW AIR DELIVERY (O - OVER)

Application suitable for server racks with vented front and rear doors.

Typical installation is on the perimeter. the units are placed along the walls of the room.

The air distribution is from the top of the unit directly into the room by a plenum (or duct).

The supply air flow can be directed through the adjustable fins of the plenum grilles.

The system is normally applied in systems where it is not possible to provide a raised floor.

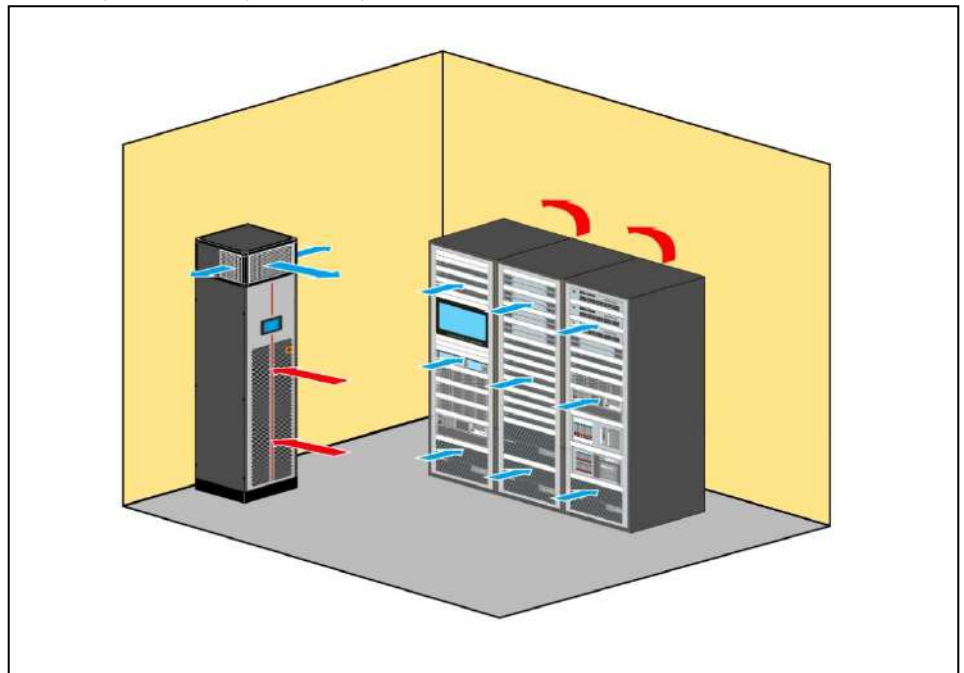



FRONT AIR DELIVERY (DL - DISPLACEMENT)

Application suitable for server racks with vented front and rear doors.
 Typical installation is on the perimeter. the units are placed along the walls of the room.
 Air suction is from the top of the unit and air delivery is horizontal into the cold aisle for cooling the racks.
 The hot air is expelled from the racks at the top or from the back.
 The system is normally applied in plant where it is not possible to provide a raised floor or ducts for air delivery.

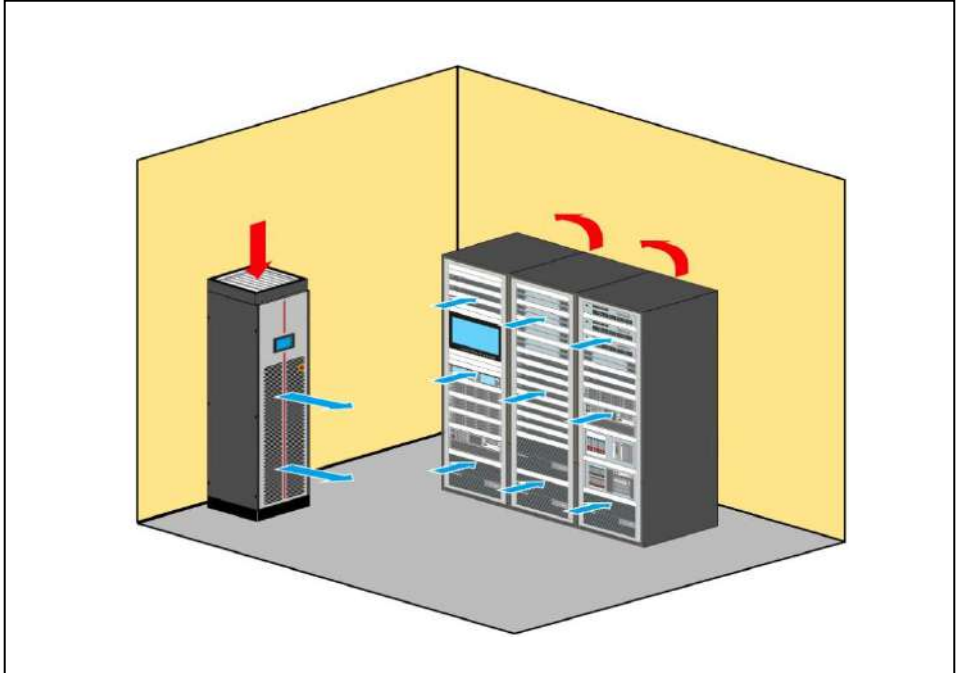

AIR CONDITIONING SYSTEM WITH DISPLACEMENT AIR DELIVERY

The basic concept of the air conditioning system with displacement air delivery is based on the natural convection principle, where the cold air is at the lower ambient zones, while the hot air is at the higher ones.
 This concept has been developed and applied for the air conditioning in Data Center, Telephone Exchangers and Hi-Tech. facilities.
 The air conditioning system with displacement air delivery supplies the cold air directly into the room at low air speed and intakes the air from the top side of the conditioner where the air temperature is higher.
 Cold air enters the rack from the front and is expelled from the top or from the rear.
 The air circulation in the rack can take place in a natural way, or through proper internal fans.





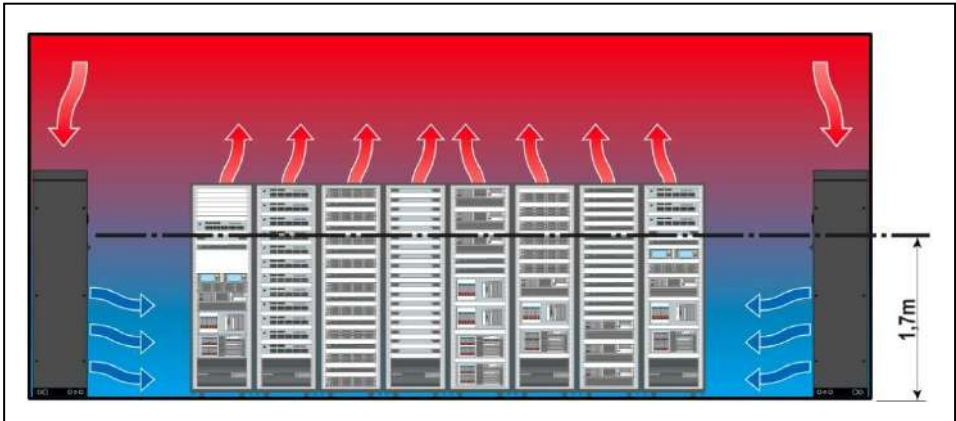















This system, together with the low air distribution speed, causes a strong stratification of the air with temperature differences of about 10°C between the coldest part and the warmest part.

For example, we can consider a temperature condition of 22°C close to the floor and 32°C close to the ceiling with a mean temperature of 26°C at 1,7m height from the floor.
 By hot air suction in the higher ambient zone, the air conditioner remarkably increases both the thermodynamic performance and the efficiency, with consequent working conditions and energy consumption optimization.



THE SERIES

The units has been designed for a quick and easy setting up. The installation requires only electrical and hydraulic connections.
A set of accessories allows to control the room temperature even in heating by electric heaters and, if necessary, also the humidity control by a modulating steam humidifier.

	UNDER	OVER	DSIPLACEMENT
Model 006 Size F1	Air flow: 1500 m ³ /h Nominal cooling capacity: 4.6 kW 	Air flow: 1500 m ³ /h Nominal cooling capacity: 4.6 kW 	Air flow: 1050 m ³ /h Nominal cooling capacity: 4.68 kW 
Model 009 Size F1	Air flow: 2200 m ³ /h Nominal cooling capacity: 7.7 kW 	Air flow: 2200 m ³ /h Nominal cooling capacity: 7.7 kW 	Air flow: 1540 m ³ /h Nominal cooling capacity: 7.6 kW 
Model 011 Size F1	Air flow: 2500 m ³ /h Nominal cooling capacity: 9.4 kW 	Air flow: 2500 m ³ /h Nominal cooling capacity: 9.4 kW 	Air flow: 1750 m ³ /h Nominal cooling capacity: 9.3 kW 
Model 013 Size F1	Air flow: 2700 m ³ /h Nominal cooling capacity: 12.1 kW 	Air flow: 2700 m ³ /h Nominal cooling capacity: 12.1 kW 	Air flow: 1750 m ³ /h Nominal cooling capacity: 10.8 kW 
Model 016 Size F2	Air flow: 4300 m ³ /h Nominal cooling capacity: 14.9 kW 	Air flow: 4300 m ³ /h Nominal cooling capacity: 14.9 kW 	Air flow: 3010 m ³ /h Nominal cooling capacity: 14.9 kW 
Model 022 Size F2	Air flow: 5000 m ³ /h Nominal cooling capacity: 19.6 kW 	Air flow: 5000 m ³ /h Nominal cooling capacity: 19.6 kW 	Air flow: 3500 m ³ /h Nominal cooling capacity: 19.2 kW 
Model 026 Size F2	Air flow: 5400 m ³ /h Nominal cooling capacity: 24.6 kW 	Air flow: 5400 m ³ /h Nominal cooling capacity: 24.6 kW 	Flusso aria: 3500 m ³ /h Nominal cooling capacity: 21.8 kW 

PRODUCT FEATURES AND BENEFITS

- Cooling capacity from 4 to 25 kW for Over (O) / Under (U) versions.
- Cooling capacity from 4 to 21 kW for Displacement (DL) versions.
- Improvement of the control software with advanced logic.
- Fast and easy installation.
- Plug fans with EC electric motors and impeller in aluminium or composite material, which guarantees a reduction of power consumption.
- New maintenance-free electric motor of the fan.
- Variable air flow according to the load.
- Cooling density for Over (O) / Under (U) versions up to 49.2 kW per m² of occupied space.
- Totally removable panelling to facilitate extraordinary maintenance operations.
- Total front access for routine maintenance operations.

MODEL IDENTIFICATION

w-AV3 O 022 F2 <H>

w-AV3 **Series**

O **Air delivery**
O = over – upflow air delivery
U = under – downflow air delivery
DL = displacement – front air delivery

022 **Model / Cooling capacity (kW) at nominal conditions**

F2 **Cabinet size**

<H> **RoHS II compliant (Directive 2011/65/UE)**

STORING TEMPERATURE

If the machine is not installed on receipt and is stored for a long time, store it in a protected place, at temperatures ranging between -30°C and 46°C in absence of superficial condensation and direct sun light.

WORKING LIMITS

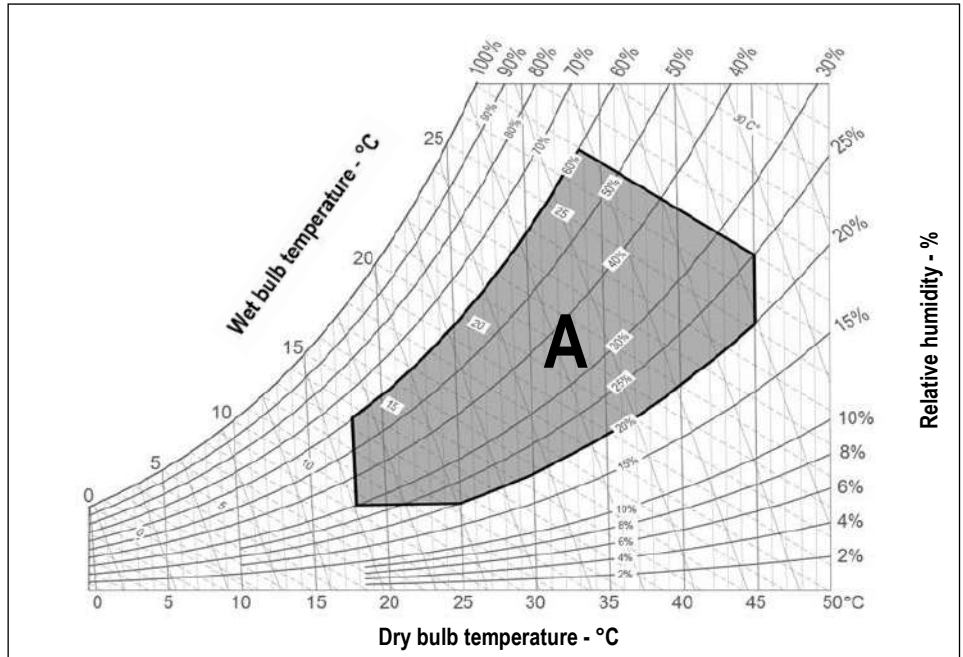

ROOM AIR CONDITIONS

Room air temperature:

- 10°C minimum temperature with wet bulb.
- 27°C maximum temperature with wet bulb.
- 18°C minimum temperature with dry bulb.
- 45°C maximum temperature with dry bulb.

AREA "A" Standard machine operating envelope.

Room air humidity:

- 20%RH minimum relative humidity.
- 60%RH maximum relative humidity.

CHILLED WATER TEMPERATURE

- 6°C Minimum chilled water inlet temperature.
- 27°C Maximum chilled water inlet temperature.
- ΔT 3°C Minimum temperature difference between chilled water inlet and outlet.
- ΔT 10°C Maximum temperature difference between chilled water inlet and outlet.

HYDRAULIC CIRCUIT

- ΔP 5-150kPa Pressure drop range of the hydraulic circuit.
- 10 Bar Maximum working pressure of the hydraulic circuit.

POWER SUPPLY

- ± 10% Maximum tolerance of the nominal supply voltage (V).
- ± 2% Maximum unbalancing of the phases.

LIMIT OF CHILLED WATER TEMPERATURE AT THE UNIT'S INLET

The table shows the recommended minimum water temperature at the unit's inlet (°C), at different ambient air conditions.

Lower chilled water temperatures may cause water droplets in the air flow or condensate drain problem.

		Room Air Temperature					
		18°C	25°C	30°C	35°C	40°C	45°C
Relative Humidity	60%	6,0	10,4	16,4	--	--	--
	50%	6,0	8,2	13,9	19,5	--	--
	40%	6,0	6,0	11,2	16,5	--	--
	30%	6,0	6,0	7,0	12,1	16,2	--
	25%	--	6,0	6,0	8,9	13,2	--
	20%	--	6,0	6,0	6,0	9,7	13,8

MAIN COMPONENTS

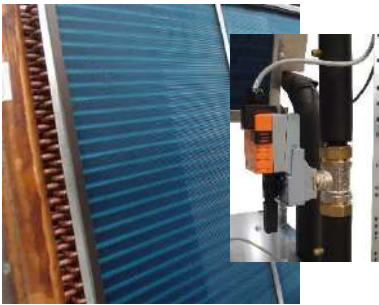

FRAMEWORK

- Base and frame in galvanized steel, painted with epoxy powders. Colour RAL 7016. The inner frame is provided with seals for the panels.
- Panels in galvanized steel sheet with protective surfaces treatment in compliance with UNI ISO 9227/ASTMB117 and ISO 7253, and painted with epoxy powders. Colour RAL 7016 hammered.
- Panels insulated with polyurethane foam based on polyester polyol with melted protective film and seals to ensure airtight. Fire resistance HF1 – UL94.
- Hinged front panels with key fasteners and removable lateral and back side panels.
- Total front routine maintenance.
- Compartment for electrical panel on unit front for direct access to control and regulation devices.
- UNDER air flow: Air intake from the top and air delivery from the bottom.
- OVER air flow: Air intake from the front and air delivery from the top with protection guard grille.
- DISPLACEMENT air flow: Air intake from the top and front air delivery.

AIR FILTERS SECTION

- Washable air filters with COARSE 60% efficiency (according to ISO EN 16890) with cells in synthetic fibre and metallic frame.
- Air filters access on unit front.

COOLING SECTION

- Heat exchanger coil with internally corrugated copper tubes and high efficiency aluminium fins, specifically developed to provide high heat transfer and lower pressure drops.
- Finned pack with hydrophilic treatment that assure the condensate water drop, high thermal conductivity and does not favour the growth of micro-organisms
- Condensate tray in stainless steel with PVC flexible discharge pipe.
- 2-way motorized valve for water flow regulation with 0÷10 VDC control actuator and emergency manual control.
- Temperature probe on chilled water inlet.
- ISO 228G/1 chilled water connection

TEMPERATURE SENSOR ON AIR INTAKE / DELIVERY

- Temperature sensor on air intake with function of temperature display.
- Temperature sensor on air delivery with function of control and regulation.

FAN SECTION

- Centrifugal fans with backward curved blades with wing profile, single suction and without scroll housings (Plug-fans), directly coupled to external rotor electric motor.
- Impeller in aluminium or in composite material exempt from rust formation.
- Brushless type synchronous EC motor with integrated electronic commutated system.
- Fans speed control with proportional signal 0-10V.
- Fan protection guard grille on discharge side for Over version.
- Available external static pressure from 20 Pa up to max, adjustable with air flow rate.

ELECTRICAL PANEL

In accordance with EN60204-1 norms, suitable for indoor installation, complete with:

- Main switch with door lock safety on front panel.
- Thermal-magnetic circuit breaker for supply fan.
- Transformer for auxiliary circuit and microprocessor supply.
- Numbered electric cables.
- Terminals for remote enabling, General Alarm signal and machine status.
- Power supply: 230/1/50.

SAFETY DEVICES

- Automatic system to disconnect the power supply to fan in case of fire or smoke alarm (detectors supplied as optional).

CONTROL SYSTEM

Microprocessor control system with graphic display for control and monitor of operating and alarms status. The system includes:

- Built-in clock for alarms date and time displaying and storing.
- Built-in memory for the storing of the intervened events (up to 200 events recorded).
- Hour-meter for main components.
- Non-volatile "Flash" memory for data storage in case of power supply faulty.
- Menu with protection password.
- LAN network for max. 15 units.
- Provision for connectivity cards housing.

OPTIONAL ACCESSORIES

The descriptions of these additional components can be found in Chapter OPTIONAL ACCESSORIES.

B263.....	Bottom air intake + blind panels. Only for OVER version. The accessory foresees the blind frontal panels and allows the intake air from the bottom of the machine.
B264.....	Back air intake + blind panels. Only for OVER version. The accessory foresees the blind frontal panels and the intake air from the rear of the machine.
A547.....	Constant flow: automatic system for the air flow control in the underfloor (Under version), in the duct (Over version). The system controls the supply fans rotation speed to keep constant the air flow in the underfloor/duct via a differential pressure transmitter connected to the microprocessor control. Not compatible with constant prevalence control system.
A548.....	Constant prevalence: automatic system for the air pressure control in the underfloor (Under version), in the duct (Over version). The system controls the supply fans rotation speed to keep constant the air pressure in the underfloor/duct via a differential pressure transmitter connected to the microprocessor control. Not compatible with constant flow control system.
B792.....	Power supply 400/3+N/50
B794.....	Power supply 230/1/60
B795.....	Power supply 230/3/60
B796.....	Power supply 380/3+N/60
B798.....	Power supply 460/3+N/60
P091.....	Back-up module controller. The system guarantees the microprocessor power supply for a few minutes, in case of supply voltage failure. Restriction: Not compatible with "Free-cooling plenum" and "Humidification".
383.....	Numbered wirings + UK requests.
.....	Serial cards:
.....	A471 - RS485 serial card.
.....	A472 - RS232 serial card.
.....	A473 - Ethernet card.
.....	A474 - LON card.
B811.....	Air flow sensor. Air flow loss alarm with differential air pressure switch connected to pressure probe on the fan suction mouth.
A381.....	Drain pump. Supplied in mounting kit.
A491.....	Water leakage detector: supplied in mounting kit.
A492.....	Water leakage detector + additional sensor: supplied in mounting kit.
A501.....	Clogged filters sensor with differential pressure switch on air side.
A511.....	Smoke detector. Supplied in mounting kit.
A521.....	Fire detector. Supplied in mounting kit.
5891.....	Control unit via kiplink..
A35B.....	Graphic display "Evolution Touch"
A352.....	No Display
A822.....	Adaptive set point: function that optimizes the operation of liquid chillers connected to the indoor air conditioners by control of the effective room thermal load.
P141.....	Analogue set-point compensation. Analogue set point compensation according to an external analogue signal at Customer care.
A842.....	Network analyser. Multifunction utility for calculating and displaying the machine electrical measurements.
A812 (1).....	Free-cooling direct control.
A791.....	Air temperature control on suction air.
B803.....	3-way 0-10V valve. 3-way motorized valve with 0÷10 VDC control actuator and emergency manual control for the third way (by-pass) of the chilled water hydraulic circuit. The valve is in substitution of the main water flow control valve.
B807.....	EPIV 2-way valve. Pressure independent 2-way modulating motorized valve with 0÷10 VDC control actuator and emergency manual control. The valve is in substitution of the main water flow control valve.
P131.....	Hot water coil + 2-way valve. Hot water heating system.
A431.....	Electric heater. Heating with electric heaters.
4301 (2).....	Steam Humidifier: Modulating steam humidifier with immersed electrodes with electronic control, all with a metal cover on the top. The optional foresee the combined Temperature / Humidity sensor on return air and control board.
P051 (3).....	Dehumidification function: The optional foresee the combined Temperature / Humidity sensor on return air.
P161.....	T/rH air intake sensor
4666.....	External air probe.
P071/P072/P073/P074.....	Remote T/rH probe: combined Temperature / Relative Humidity probe. For remote installation, in addition to the combined probe on the air intake of the unit..

P113.....	Dual power supply – External ATS: kit for double power supply with automatic change-over supplied in mounting kit.
P084.....	Air filter ePM₁₀ 50% : High efficiency air filter (according to ISO EN 16890).
A532.....	Damper with spring return : non-return air damper driven by electric servomotor installed on the top of units for all versions. The optional is not suitable for installation in seismic areas.
P011.....	Empty plenum . The optional is not suitable for installation in seismic areas.
P012.....	Empty plenum CL. A1 (EN 13501-1) . Plenum with fire reaction in class “A1”. The optional is not suitable for installation in seismic areas.
P013.....	Plenum + 3 grilles on three sides with double adjustable row. The optional is not suitable for installation in seismic areas.
P014.....	Plenum + 3 grilles CL. A1 (EN 13501-1) . Plenum with grilles on three sides with double adjustable row, with fire reaction in class “A1”. The optional is not suitable for installation in seismic areas.
P015.....	Silenced plenum . The optional is not suitable for installation in seismic areas.
P016.....	Silenced plenum + 1 grille : Plenum with grille with double adjustable row on front side and sound absorbers. The optional is not suitable for installation in seismic areas.
P031.....	Empty intake plenum . The optional is not suitable for installation in seismic areas.
P032.....	Empty intake plenum CL. A1 (EN 13501-1) . Plenum with fire reaction in class “A1”. The optional is not suitable for installation in seismic areas.
P033.....	Silenced intake plenum . The optional is not suitable for installation in seismic areas.
P034 (4)	Intake free-cooling plenum for Under version. The optional foresee the combined Temperature / Humidity sensor on machine air suction, the Temperature sensor for ambient air and the expansion board for the microprocessor control. The optional is not suitable for installation in seismic areas.
P041 / P042 / P043.....	Support frame with height adjusting rubber holders. It is not possible to match the unit floor stand with plenum installed under the machine. The optional is not suitable for installation in seismic areas.
A272.....	CL. A1 (EN 13501-1) insulation : Panelling with fire reaction in class “A1”.
P151.....	Lowered display for Under : for units equipped with plenum under the unit.
9973	Wooden cage packing . The machines are delivered on pallet, covered with shrink wrap and packaged in wooden cage.
P101.....	Anti-seismic fixing kit , supplied in mounting kit.
T500000310	Additional condensate tray in peraluman for Under version size F1.
T500000311	Additional condensate tray in peraluman for Under version size F2.
LM8300023	Unit bind bracket to fix the unit to the wall size F1.
LM8300054	Unit bind bracket to fix the unit to the wall size F2.
B912.....	Remote keyboard K200 . Graphic display for remote installation, the optional is added to the standard graphic display placed on machine frontal panel..

WARNING

The Manufacturer reserves the right to accept the matching of the optional installed on the machine.

MANDATORY COMBINATIONS OF ACCESSORIES

- When optional accessory “A812 Free cooling direct control” is present, it requires mandatory accessories “P161 T/rH air intake sensor” and “4666 External air probe”.
- When optional accessories “4301 Steam humidifier” are present, they require mandatory accessory “P161 T/rH air intake sensor”.
- When optional accessory “P051 Dehumidification function” is present, it requires mandatory accessory “P161 T/rH air intake sensor”.
- When optional accessory “P034 Intake free-cooling plenum” is present, it requires mandatory accessories “P161 T/rH air intake sensor”, “4666 External air probe”, “A812 Free-cooling direct control”.
- When accessory A352 “NO DISPLAY” is present, it requires mandatory accessory 5891 “Unit control via Kiplink”

TECHNICAL DATA – UNDER / OVER version

MODEL		006	009	011	013	016	022	026
SIZE		F1	F1	F1	F1	F2	F2	F2
VERSION (1)		U / O	U / O	U / O	U / O	U / O	U / O	U / O
COOLING CAPACITY (2)								
Total	kW	4.74	7.90	9.66	12.5	15.4	20.4	25.6
Sensible	kW	4.74	7.90	9.66	12.5	15.4	20.4	25.6
SHR (3)		1.0	1.0	1.0	1.0	1.0	1.0	1.0
"EC" SUPPLY FAN								
Air flow	m ³ /h	1500	2200	2500	2700	4300	5000	5400
Nominal external static pressure	Pa	20	20	20	20	20	20	20
Maximum external static pressure	Pa	201	471	384	268	277	362	246
Power input (4)	kW	0.07	0.21	0.32	0.45	0.40	0.68	0.95
COOLING COIL								
Water flow rate (2)	m ³ /h	0.83	1.37	1.66	2.16	2.66	3.50	4.40
dP coil + valve (2)	kPa	37.1	61.1	32.2	55.7	46.5	80.2	108
Water content	l	1.6	2.3	3.1	4.7	4.4	5.9	8.9
UNIT ELECTRIC DATA								
Electric panel power input	kW	0.015	0.015	0.015	0.015	0.015	0.015	0.015
SOUND LEVEL ISO 3744 (5)								
Pressure level	dB(A)	42	56	58	60	53	60	62
Power level	dB(A)	58	72	74	76	69	76	78
AIR FILTERS								
Extended filtering surface	m ²	0.68	0.68	0.68	0.68	1.05	1.05	1.05
Efficiency (ISO EN 16890)	COARSE	60%	60%	60%	60%	60%	60%	60%
ENERGY EFFICIENCY INDEX (2)								
EER Energy Efficiency Ratio	kW/kW	67.7	37.6	30.2	27.8	38.5	30.0	26.9
DIMENSIONS								
Length	mm	600	600	600	600	1000	1000	1000
Depth	mm	500	500	500	500	500	500	500
Height	mm	1980	1980	1980	1980	1980	1980	1980
NET WEIGHT Over								
	kg	103	109	116	120	163	173	181
NET WEIGHT Under								
	kg	110	118	126	130	173	183	191
CONNECTIONS								
Cooling coil inlet/outlet – ISO 228/1-G	Ø	3/4"	3/4"	3/4"	1"	1+1/4"	1+1/4"	1+1/4"
Condensate (6)	Ø mm	19	19	19	19	19	19	19
Power supply wiring cable (7)	No. x mm ²	3G1.5	3G1.5	3G1.5	3G1.5	3G1.5	3G1.5	3G1.5

THE COOLING CAPACITY DOES NOT CONSIDER THE SUPPLY FAN MOTOR THERMAL LOAD

1. U = Under, downflow / O = Over, upflow.
2. Gross value. Characteristics referred to entering air at 26°C-40% RH; Chilled water temperature 10-15°C – glycol solution 0%; ESP=20Pa.
3. SHR = Sensible cooling capacity / Total cooling capacity.
4. Corresponding to the nominal ESP=20Pa.
5. Sound pressure level on air return at 1m.
6. Rubber pipe – referred to internal diameter.
7. Minimum section of the power cable for units without accessories.

TECHNICAL DATA – DISPLACEMENT version

MODEL		006	009	011	013	016	022	026
SIZE		F1	F1	F1	F1	F2	F2	F2
VERSION (1)		DL	DL	DL	DL	DL	DL	DL
COOLING CAPACITY (2)								
Total	kW	4.68	7.64	9.32	10.8	14.9	19.2	21.8
Sensible	kW	4.68	7.64	9.32	10.8	14.9	19.2	21.8
SHR (3)		1.0	1.0	1.0	1.0	1.0	1.0	1.0
"EC" SUPPLY FAN								
No.		1	1	1	1	2	2	2
Air flow	m ³ /h	1050	1540	1750	1750	3010	3500	3500
Nominal external static pressure	Pa	20	20	20	20	20	20	20
Maximum external static pressure	Pa	127	304	347	316	302	334	314
Power input (4)	kW	0.06	0.18	0.26	0.28	0.33	0.53	0.56
COOLING COIL								
Water flow rate (2)	m ³ /h	0.79	1.33	1.62	1.87	2.56	3.30	3.74
dP coil + valve (2)	kPa	36.5	57.7	30.2	42.6	44.0	72.4	81.3
Water content	l	1.6	2.3	3.1	4.7	4.4	5.9	8.9
UNIT ELECTRIC DATA								
Electric panel power input	kW	0.015	0.015	0.015	0.015	0.015	0.015	0.015
SOUND LEVEL ISO 3744 (5)								
Pressure level	dB(A)	46	54	57	57	56	59	59
Power level	dB(A)	62	70	73	73	72	75	75
AIR FILTERS								
No.		1	1	1	1	2	2	2
Extended filtering surface	m ²	0.68	0.68	0.68	0.68	1.05	1.05	1.05
Efficiency (ISO EN 16890)	COARSE	60%	60%	60%	60%	60%	60%	60%
ENERGY EFFICIENCY INDEX (2)								
EER Energy Efficiency Ratio	kW/kW	78.0	42.4	35.8	38.6	45.2	36.2	38.9
DIMENSIONS								
Length	mm	600	600	600	600	1000	1000	1000
Depth	mm	500	500	500	500	500	500	500
Height	mm	2120	2120	2120	2120	2120	2120	2120
NET WEIGHT								
	kg	116	121	130	134	182	187	195
CONNECTIONS								
Cooling coil inlet/outlet – ISO 228/1-G	Ø	3/4"	3/4"	3/4"	1"	1+1/4"	1+1/4"	1+1/4"
Condensate (6)	Ø mm	19	19	19	19	19	19	19
Power supply wiring cable (7)	No. x mm ²	3G1.5	3G1.5	3G1.5	3G1.5	3G1.5	3G1.5	3G1.5

THE COOLING CAPACITY DOES NOT CONSIDER THE SUPPLY FAN MOTOR THERMAL LOAD

- DL = Displacement air flow.
- Gross value. Characteristics referred to entering air at 30°C-30% RH; Chilled water temperature 10-15°C – glycol solution 0%; ESP=20Pa.
- SHR = Sensible cooling capacity / Total cooling capacity.
- Corresponding to the nominal ESP=20Pa.
- Sound pressure level on air return at 1m.
- Rubber pipe – referred to internal diameter.
- Minimum section of the power cable for units without accessories.

ACTIVE REDUNDANCY



Chilled water units, thanks to its electronically commutated EC fans, the 2-way motorized valves for chilled water flow control and an advanced algorithm to balance the heat loads among the units (including the units in stand-by), achieve an ACTIVE REDUNDANCY combining reliability, efficiency and reduced Total Cost of Ownership.

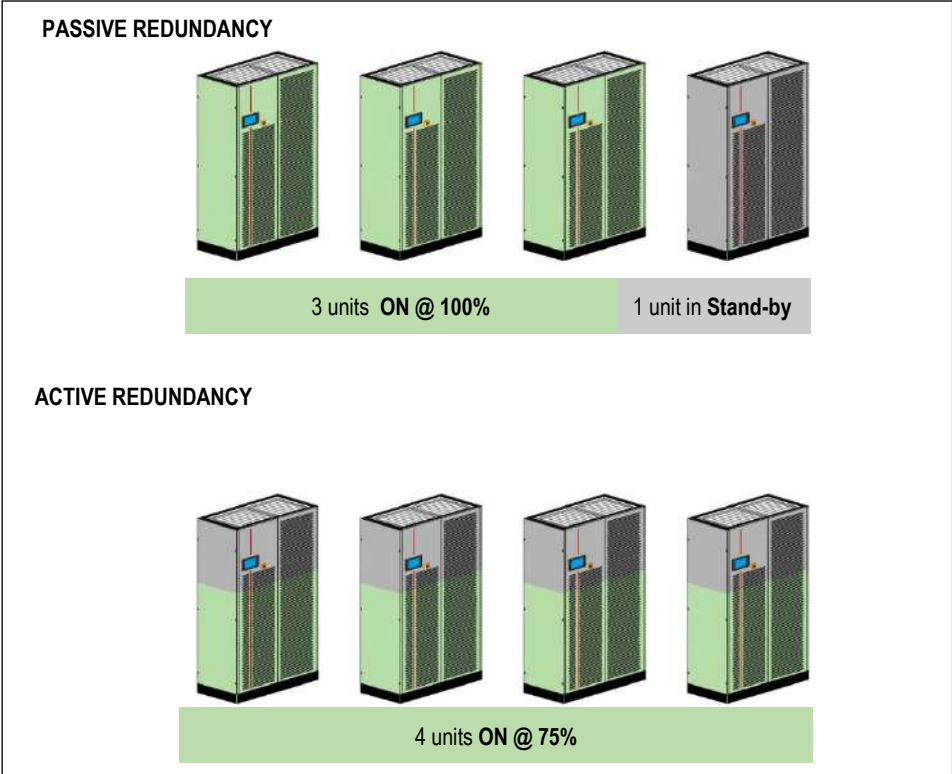

HYDRAULIC CIRCUIT

The diagrams refer to the standard configuration, without optional.

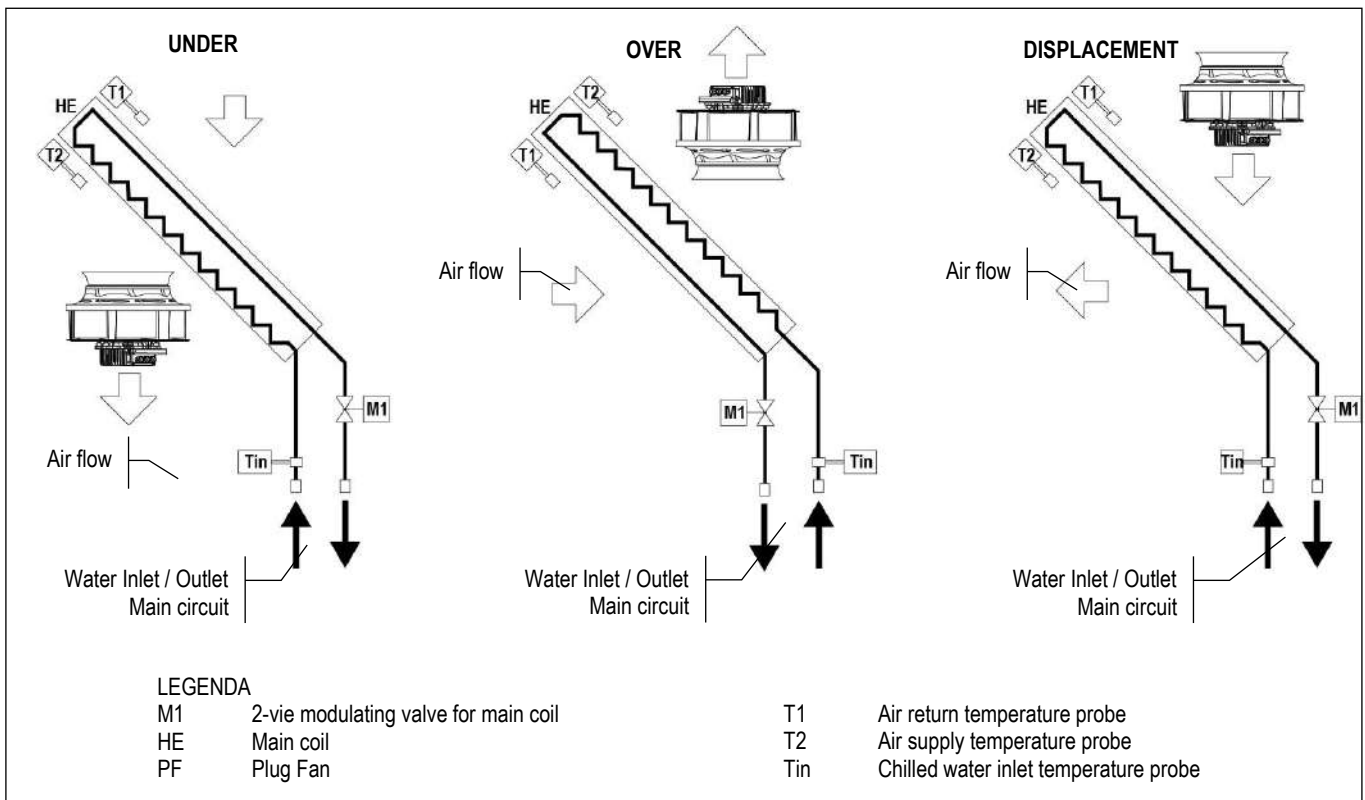

2-WAY BALL VALVE FOR CHILLED WATER FLOW CONTROL



The water flow control in the finned coil is achieved through a **2-way modulating ball valve with equal percentage flow control** ensured by the integrated characterizing disc.

This type of valve offers the following series of benefits:

- Equal percentage flow control.
- No peaks initial flow.
- Excellent stability control thanks to the integrated characterizing disc.
- Excellent characteristic in partialisation.
- Stability in control.
- Maintenance free.
- Self-cleaning.

CHARACTERISTICS OF THE 2-WAY BALL VALVE

- Closing seal with leakage rate in Class A (EN 12266-1)
- Maximum fluid pressure $P_s=1600\text{kPa}$
- Maximum closing pressure (Close-off) $\Delta P_s=1400\text{kPa}$

The rotative actuator is controlled by a signal 0 ... 10VDC from the microprocessor controller. The actuator is equipped with an emergency button for manual operation and is maintenance-free.

WATER QUALITY OF THE HYDRAULIC CIRCUITS

The values shown in the table must be guaranteed during the entire life cycle of the machine.

Ref.	Description	Symbol	Range
1	Hydrogen Ions	pH	7.5 ÷ 9
2	Presence of calcium (Ca) and magnesium (Mg)	Hardness	4 ÷ 8.5 °D
3	Chlorine ions	Cl ⁻	< 150 ppm
4	Iron Ions	Fe ³⁺	< 0.5 ppm
5	Manganese Ions	Mn ²⁺	< 0.05 ppm
6	Carbon dioxide	CO ₂	< 10 ppm
7	Hydrogen sulphide	H ₂ S	< 50 ppb
8	Oxygen	O ₂	< 0.1 ppm
9	Chlorine	Cl ₂	< 0.5 ppm
10	Ammonia	NH ₃	< 0.5 ppm
11	Ratio between carbonates and sulphates	HCO ₃ ⁻ /SO ₄ ²⁻	> 1
12	Sulphate ions	SO ₄ ⁻	< 100 ppm
13	Phosphate ions	PO ₄ ³⁻	< 2.0 ppm

where: $1/1.78^\circ\text{D} = 1^\circ\text{Fr}$ with $1^\circ\text{Fr} = 10 \text{ gr CaCO}_3 / \text{m}^3$

ppm = parts for millions

ppb = part for billion

Explanatory notes:

- ref.1: A greater concentration of hydrogen ions (pH) than 9 implies a high risk of deposits, whereas a lower pH than 7 implies a high risk of corrosion.
- ref.2: The hardness measures the amount of Ca and Mg carbonate dissolved in the water with a temperature lower than 100°C (temporary hardness). A high hardness implies a high risk of deposits.
- ref.3: The concentration of chloride ions with higher values than those indicated causes corrosion.
- ref. 4 - 5 - 8: The presence of iron and manganese ions and oxygen leads to corrosion.
- ref.6 - 7: Carbon dioxide and hydrogen sulphide are impurities that promote corrosion.
- ref.9: Usually in water from the waterworks it is a value of between 0.2 and 0.3 ppm. High values cause corrosion.
- ref.10: The presence of ammonia reinforces the oxidising power of oxygen.
- ref.11: Below the value shown in the table, there is a risk of corrosion due to the trigger of galvanic currents between copper and other less noble metals.
- ref.12: The presence of sulphates ions triggers corrosion phenomenon.
- ref.13: The presence of phosphates ions triggers corrosion phenomenon.

It is necessary to carry out periodic checks, with withdrawals at different points of the hydraulic system. During the first year of operation, checks are recommended every 4 months which can be reduced every 4 months starting from the second year of operation.

WARNING:

Values of the parameters outside the indicated ranges can lead to the formation of deposits and limescale and/or favour corrosive phenomena within the plant. For operating fluids other than water (mixtures of ethylene and propylene glycol) it is recommended to use specific inhibitors, designed to offer thermal stability within the operating temperature range and protection against corrosion. It is necessary that, in the presence of dirty and / or aggressive waters, an intermediate heat exchanger is installed upstream of the heat exchangers.

ANTIFREEZE MIXTURES

In plants that are not adequately protected by heating cables, protect the hydraulic circuit with an anti-freeze mixture when the ambient air temperature can drop below 5°C.

Minimum ambient air temperature	°C	5	0	-5	-10	-15	-20	-25	-30
ETHYLENE GLYCOL (suggested % in weight)	%	0	12	20	30	35	40	45	50
Minimum ambient air temperature	°C	5	2	-3	-9	-13	-17	-23	-29
PROPYLENE GLYCOL (suggested % in weight)	%	0	10	20	30	35	40	45	50

The values are indicative and may significantly vary depending on the glycol manufacturer. Refer to your glycol supplier for detail.
 The values consider a precautionary difference of 5°C between the minimum ambient air temperature and the freezing temperature of the mixture.
 In the hydraulic circuit do not send fluids other than water or mixtures with ethylene / propylene glycol. If other products are provided, in addition to mixtures of water and ethylene or propylene glycol, contact the Manufacturer to check the compatibility with the machine components.

ACOUSTIC DATA

Acoustic data of the standard machines at full load working conditions.

WARNING:

In a room the noise produced by a sound source reaches the listener in two different ways:

- Directly.
- Reflected from the surrounding walls, floor, ceiling and furniture.

With the same sound source, the noise produced in a room is greater than that produced outdoors. In fact, the sound pressure level generated by the source must be added to the one reflected from the room. Also, the shape of the room affects the sound.

MODEL		006	009	011	013	016	022	026
SIZE		F1	F1	F1	F1	F2	F2	F2
VERSION (1)		U / O	U / O	U / O	U / O	U / O	U / O	U / O
SOUND LEVEL ISO EN 3744 (2)								
On air delivery	dB(A)	49.9	63.9	65.9	67.9	60.2	67.2	69.2
On air intake UNDER	dB(A)	45.6	59.6	61.6	63.6	55.9	62.9	64.9
On front side OVER	dB(A)	40.6	54.6	56.6	58.6	51.0	58.0	60.0
On front side UNDER	dB(A)	35.9	49.9	51.9	53.9	46.3	53.3	55.3
MODEL		006	009	011	013	016	022	026
SIZE		F1	F1	F1	F1	F2	F2	F2
VERSION (1)		DL	DL	DL	DL	DL	DL	DL
SOUND LEVEL ISO EN 3744 (2)								
On front side	dB(A)	46	54	57	57	56	59	59

1. U = Under, downflow / O = Over, upflow / DL = Displacement air flow
2. Sound Pressure level at 1 meter in free field – ISO EN 3744



ELECTRICAL DATA

Electrical data of the unit at full load working conditions.

230/1/50-60 POWER SUPPLY - UNDER / OVER VERSION

MODEL		006	009	011	013	016	022	026
SIZE		F1	F1	F1	F1	F2	F2	F2
VERSION (1)		U / O	U / O	U / O	U / O	U / O	U / O	U / O
Power supply	V/Ph/Hz	230/1/50-60	230/1/50-60	230/1/50-60	230/1/50-60	230/1/50-60	230/1/50-60	230/1/50-60
Starting current (SA)	A	3.6	4.0	4.0	4.0	7.2	8.0	8.0
MAX ABSORBED CURRENT (FLA)								
Only cooling	A	3.6	4.0	4.0	4.0	7.2	8.0	8.0
Cooling + Heating	A	14.9	15.3	15.3	15.3	24.1	24.9	24.9
Cooling + Humidifier	A	17.7	18.1	18.1	18.1	21.3	22.1	22.1
Cooling + Heating + Humidifier	A	29.0	29.4	29.4	29.4	38.2	39.0	39.0

230/1/50-60 POWER SUPPLY – DISPLACEMENT VERSION

MODEL		006	009	011	013	016	022	026
SIZE		F1	F1	F1	F1	F2	F2	F2
VERSION (1)		DL	DL	DL	DL	DL	DL	DL
Power supply	V/Ph/Hz	230/1/50-60	230/1/50-60	230/1/50-60	230/1/50-60	230/1/50-60	230/1/50-60	230/1/50-60
Starting current (SA)	A	3.5	3.5	3.5	3.5	7.0	7.0	7.0
MAX ABSORBED CURRENT (FLA)								
Only cooling	A	3.5	3.5	3.5	3.5	7.0	7.0	7.0
Cooling + Heating	A	14.8	14.8	14.8	14.8	23.9	23.9	23.9
Cooling + Humidifier	A	17.6	17.6	17.6	17.6	21.1	21.1	21.1
Cooling + Heating + Humidifier	A	28.9	28.9	28.9	28.9	38.0	38.0	38.0

400/3+N/50 POWER SUPPLY - UNDER / OVER VERSION

MODEL		006	009	011	013	016	022	026
SIZE		F1	F1	F1	F1	F2	F2	F2
VERSION (1)		U / O	U / O	U / O	U / O	U / O	U / O	U / O
Power supply	V/Ph/Hz	400/3+N/50	400/3+N/50	400/3+N/50	400/3+N/50	400/3+N/50	400/3+N/50	400/3+N/50
Starting current (SA)	A	3.6	4.0	4.0	4.0	7.2	8.0	8.0
MAX ABSORBED CURRENT (FLA)								
Only cooling	A	3.6	4.0	4.0	4.0	7.2	8.0	8.0
Cooling + Heating	A	11.3	11.3	11.3	11.3	16.9	16.9	16.9
Cooling + Humidifier	A	14.1	14.1	14.1	14.1	14.1	14.1	14.1
Cooling + Heating + Humidifier	A	14.1	14.1	14.1	14.1	16.9	16.9	16.9

400/3+N/50 POWER SUPPLY – DISPLACEMENT VERSION

MODEL		006	009	011	013	016	022	026
SIZE		F1	F1	F1	F1	F2	F2	F2
VERSION (1)		DL	DL	DL	DL	DL	DL	DL
Power supply	V/Ph/Hz	400/3+N/50	400/3+N/50	400/3+N/50	400/3+N/50	400/3+N/50	400/3+N/50	400/3+N/50
Starting current (SA)	A	3.5	3.5	3.5	3.5	7.0	7.0	7.0
MAX ABSORBED CURRENT (FLA)								
Only cooling	A	3.5	3.5	3.5	3.5	7.0	7.0	7.0
Cooling + Heating	A	11.3	11.3	11.3	11.3	16.9	16.9	16.9
Cooling + Humidifier	A	14.1	14.1	14.1	14.1	14.1	14.1	14.1
Cooling + Heating + Humidifier	A	14.1	14.1	14.1	14.1	16.9	16.9	16.9

230/3/60 POWER SUPPLY - UNDER / OVER VERSION

MODEL		006	009	011	013	016	022	026
SIZE		F1	F1	F1	F1	F2	F2	F2
VERSION (1)		U / O	U / O	U / O	U / O	U / O	U / O	U / O
Power supply	V/Ph/Hz	230/3/60	230/3/60	230/3/60	230/3/60	230/3/60	230/3/60	230/3/60
Starting current (SA)	A	3.6	4.0	4.0	4.0	7.2	8.0	8.0
MAX ABSORBED CURRENT (FLA)								
Only cooling	A	3.6	4.0	4.0	4.0	7.2	8.0	8.0
Cooling + Heating	A	11.3	11.3	11.3	11.3	16.9	16.9	16.9
Cooling + Humidifier	A	14.1	14.1	14.1	14.1	14.1	14.1	14.1
Cooling + Heating + Humidifier	A	14.1	14.1	14.1	14.1	16.9	16.9	16.9

1. U = Under, downflow / O = Over, upflow / DL = Displacement

230/3/60 POWER SUPPLY – DISPLACEMENT VERSION

MODEL		006	009	011	013	016	022	026
SIZE		F1	F1	F1	F1	F2	F2	F2
VERSION (1)		DL	DL	DL	DL	DL	DL	DL
Power supply	V/Ph/Hz	230/3/60	230/3/60	230/3/60	230/3/60	230/3/60	230/3/60	230/3/60
Starting current (SA)	A	3.5	3.5	3.5	3.5	7.0	7.0	7.0
MAX ABSORBED CURRENT (FLA)								
Only cooling	A	3.5	3.5	3.5	3.5	7.0	7.0	7.0
Cooling + Heating	A	11.3	11.3	11.3	11.3	16.9	16.9	16.9
Cooling + Humidifier	A	14.1	14.1	14.1	14.1	14.1	14.1	14.1
Cooling + Heating + Humidifier	A	14.1	14.1	14.1	14.1	16.9	16.9	16.9

380/3+N/60 POWER SUPPLY - UNDER / OVER VERSION

MODEL		006	009	011	013	016	022	026
SIZE		F1	F1	F1	F1	F2	F2	F2
VERSION (1)		U / O	U / O	U / O	U / O	U / O	U / O	U / O
Power supply	V/Ph/Hz	380/3+N/60	380/3+N/60	380/3+N/60	380/3+N/60	380/3+N/60	380/3+N/60	380/3+N/60
Starting current (SA)	A	3.6	4.0	4.0	4.0	7.2	8.0	8.0
MAX ABSORBED CURRENT (FLA)								
Only cooling	A	3.6	4.0	4.0	4.0	7.2	8.0	8.0
Cooling + Heating	A	10.8	10.8	10.8	10.8	16.2	16.2	16.2
Cooling + Humidifier	A	14.6	14.6	14.6	14.6	14.6	14.6	14.6
Cooling + Heating + Humidifier	A	14.6	14.6	14.6	14.6	16.2	16.2	16.2

380/3+N/60 POWER SUPPLY – DISPLACEMENT VERSION

MODEL		006	009	011	013	016	022	026
SIZE		F1	F1	F1	F1	F2	F2	F2
VERSION (1)		DL	DL	DL	DL	DL	DL	DL
Power supply	V/Ph/Hz	380/3+N/60	380/3+N/60	380/3+N/60	380/3+N/60	380/3+N/60	380/3+N/60	380/3+N/60
Starting current (SA)	A	3.5	3.5	3.5	3.5	7.0	7.0	7.0
MAX ABSORBED CURRENT (FLA)								
Only cooling	A	3.5	3.5	3.5	3.5	7.0	7.0	7.0
Cooling + Heating	A	10.8	10.8	10.8	10.8	16.2	16.2	16.2
Cooling + Humidifier	A	14.6	14.6	14.6	14.6	14.6	14.6	14.6
Cooling + Heating + Humidifier	A	14.6	14.6	14.6	14.6	16.2	16.2	16.2

460/3+N/60 POWER SUPPLY- UNDER / OVER VERSION

MODEL		006	009	011	013	016	022	026
SIZE		F1	F1	F1	F1	F2	F2	F2
VERSION (1)		U / O	U / O	U / O	U / O	U / O	U / O	U / O
Power supply	V/Ph/Hz	460/3+N/60	460/3+N/60	460/3+N/60	460/3+N/60	460/3+N/60	460/3+N/60	460/3+N/60
Starting current (SA)	A	3.6	4.0	4.0	4.0	7.2	8.0	8.0
MAX ABSORBED CURRENT (FLA)								
Only cooling	A	3.6	4.0	4.0	4.0	7.2	8.0	8.0

460/3+N/60 POWER SUPPLY – DISPLACEMENT VERSION

MODEL		006	009	011	013	016	022	026
SIZE		F1	F1	F1	F1	F2	F2	F2
VERSION (1)		DL	DL	DL	DL	DL	DL	DL
Power supply	V/Ph/Hz	460/3+N/60	460/3+N/60	460/3+N/60	460/3+N/60	460/3+N/60	460/3+N/60	460/3+N/60
Starting current (SA)	A	3.5	3.5	3.5	3.5	7.0	7.0	7.0
MAX ABSORBED CURRENT (FLA)								
Only cooling	A	3.5	3.5	3.5	3.5	7.0	7.0	7.0
Cooling + Humidifier	A	7.54	7.54	7.54	7.54	11.0	11.0	11.0

1. U = Under, downflow / O = Over, upflow / DL = Displacement

MICROPROCESSOR CONTROL SYSTEM



Controller



Keyboard and Display



7" Touch Graphic Display (optional)

The indoor unit is equipped with the controller connected to a 6 keys keyboard with graphic display on which all information in English language or easily identifiable symbols are displayed. The controller disposes of a "flash" memory that preserves the information even in absence of power supply. Part of memory is dedicated to the registration of intervened events - up to 200 events. The system can manage up to 4 T/H probes on air intake, 4 T/H probes on air delivery, 4 remote T/H probes and a T/H probe for outdoor air.

DISPLAY - KEYBOARD FUNCTIONS

	ALARM	Alarm presence with red light. Push for alarm description. In case of more alarms scroll by UP / DOWN.
	PRG	Menu list scrolled by UP/DOWN: Unit; Set-point; In/Out; Clock; History; User; Service; Factory. ENTER to execute.
	ESC	Home. Used to come back to the previous menu level or to the main screen.
	UP DOWN	Changes pages and values of sets. By pressing in HOME mask, the synoptic of the main controls is displayed.
	ENTER	Moving the cursor on adjustable Program(s) fields to confirm the changes. Press ENTER to get out the fields.

DISPLAY - MAIN MASK

area 11	area 1	area 12	HH	:	MM	DD	/	MM	/	YY
	area 2		-	9	9	.	9	°C		
	area 3		-	9	9	.	9	%		
	area 4	area 3_4						area 8		
	area 5	area 6	area 7					area 9		area 10

The main mask shows time, date, room temperature and humidity values (if the relative probe is present) and areas for displaying operating and alarm status with dedicated icons:

- Area 1: Status of the unit: on / off
- Area 2: Status detail
- Area 3: Type of event (only in case of an event)
- Area 3_A: Code and type of event
- Area 4: Active cooling devices
- Area 5: Active free-cooling devices
- Area 6: Active humidity devices
- Area 7: Active heating devices
- Area 8: on / off parameters
- Area 9: BMS address
- Area 10: LAN address
- Area 11: Schematic representation of units

CONNECTIVITY

Using serial cards supplied as an accessory, the microprocessor control of the machine allows communication with modern remote management systems for buildings and plants with the following protocols: MODBUS, LON, BACNET MS / TP RS485, BACNET OVER IP.

SYSTEM DIAGRAM

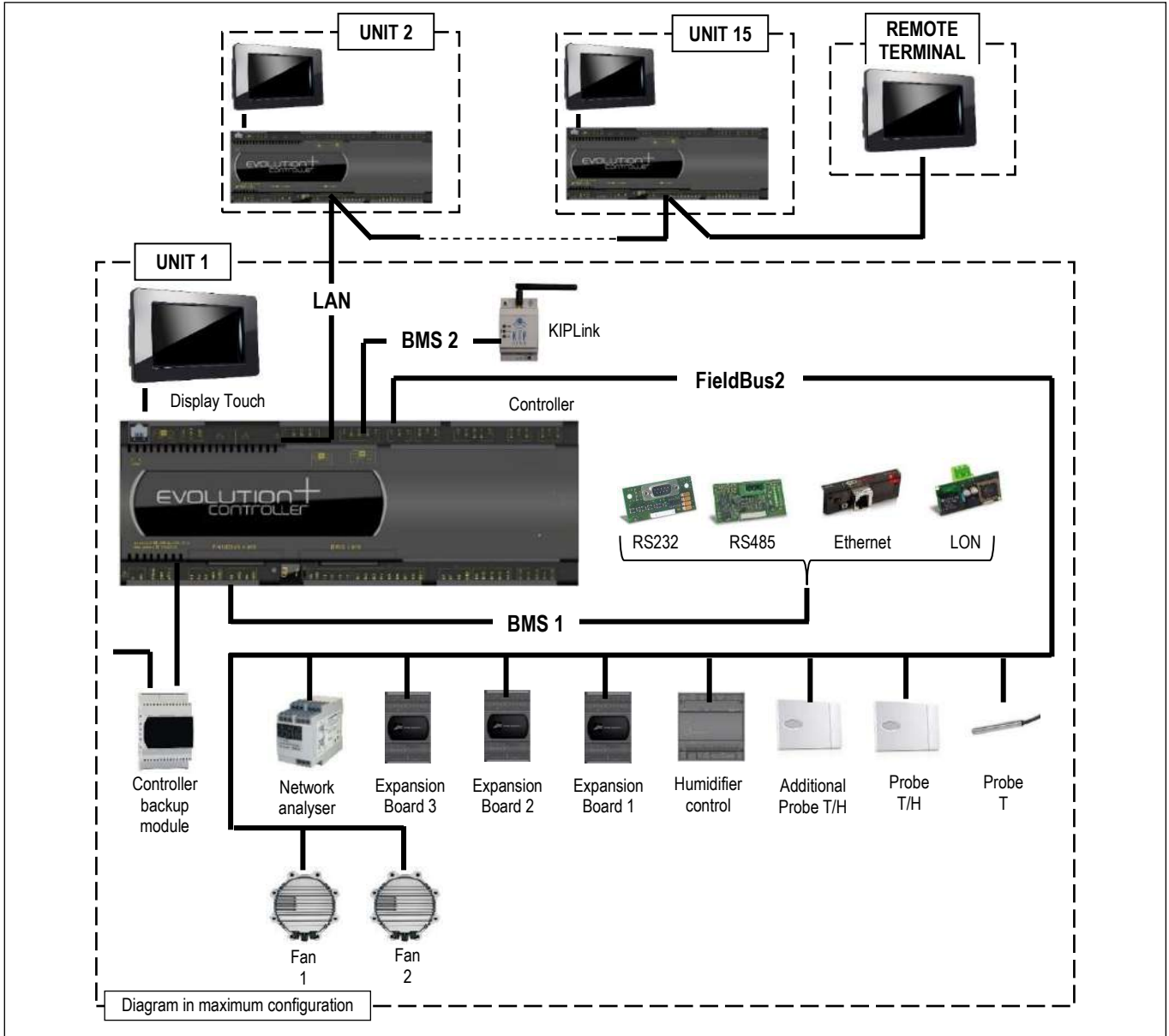

LAN NETWORK

The LAN is part of the control software and it is possible to connect up to 15 units. This type of connection allows to control the units in coherent way, moreover the units can be controlled and managed from a shared remote terminal.

LAN ADDRESS LIST

Units n.	1	2	3	4	5	6	7	8	9	10	11	12	13	14	15	Remote terminal
Controller address	1	2	3	4	5	6	7	8	9	10	11	12	13	14	15	---
Display & Keyboard address	16	17	18	19	20	21	22	23	24	25	26	27	28	29	30	32

The unit connection to the local network (LAN) allows to perform the following functions:

- Balancing the operating hours among the different units by rotating the reserve units.
- Turning on the reserve units in case other units should turn off due to an alarm, maintenance or power feed interruption.
- Turning on reserve units to offset the excessive thermal load.
- Operating with all units based on the average temperature and humidity values read by the temperature probes only in the operating units.
- DYNAMIC MASTER function that makes the role of the Master unit dynamic. In case of alarm, shutdown, maintenance, power failure, etc. on the Master unit, the function automatically elects a new Master unit.

OPTIONAL ACCESSORIES: P122 - BOTTOM AIR INTAKE+BLIND PANELS

Not available for Under (U) and Displacement (DL) units.
 Thanks to the design of the basement is possible the air suction from the unit bottom. The air flow rate is the nominal one.
 The accessory foresees the blind frontal panels.

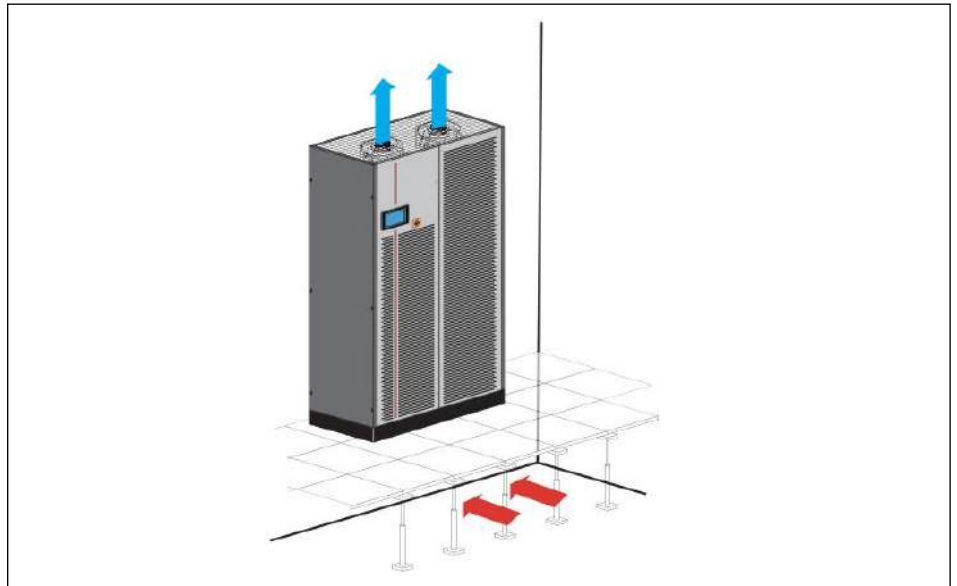

OPTIONAL ACCESSORIES: B264 – BACK AIR INTAKE+BLIND PANELS

Not available for Under (U) and Displacement (DL) units.
 The accessory foresees the air intake from the unit back side and the blind frontal panels.
 The rear air intake opening is sized for the total air flow.
 The realization of the rear opening is at Customer care.

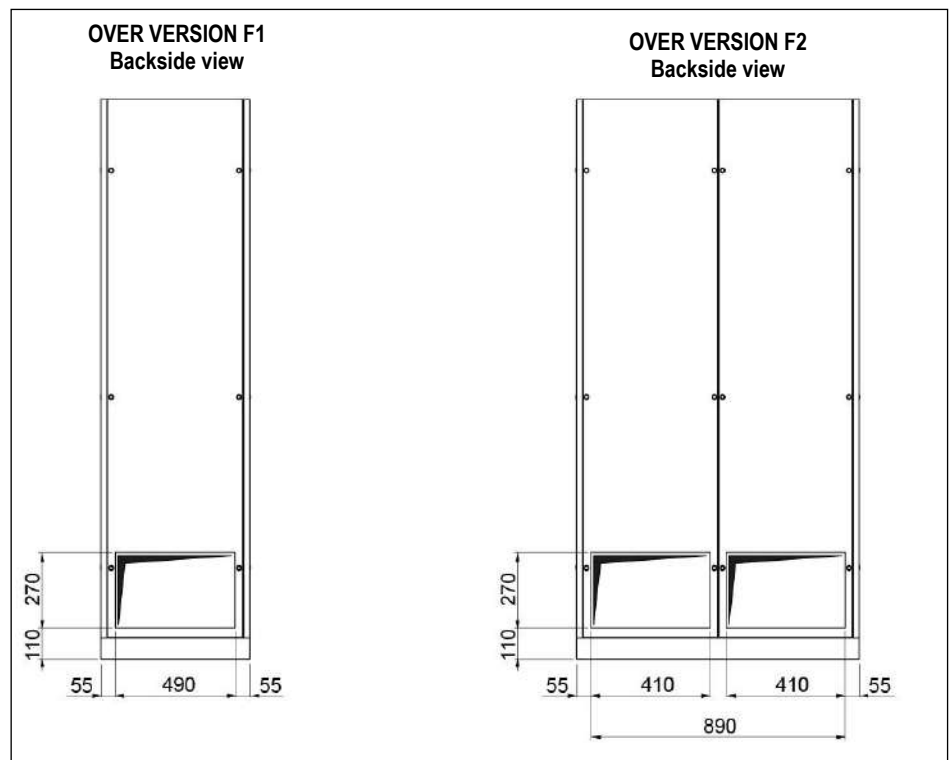

OPTIONAL ACCESSORIES: A547 / A548 - CONSTANT FLOW / CONSTANT PREVALENCE

Not available for Displacement (DL) units.

The optional is a differential pressure sensor with a 0...20mA output signal. The device is installed in the machine.

The sensor is connected to the microprocessor control of the indoor unit and allows the control of:

A547 - CONSTANT FLOW

The system controls the air flow of the air conditioner by measuring the static pressure before the inlet nozzle of the fan with the static pressure in the inlet ring.

Pressure control range from 0 to 1000 Pa.

The air flow control system is not compatible with constant prevalence control system.

A548 - CONSTANT PREVALENCE

The system controls the air pressure in the raised floor (Under version) or in the duct (Over version).

Through the relief piping of the room pressure (low pressure side) and the air supply of the fan (high pressure side) the fan rotation speed is controlled to keep the air pressure constant.

Pressure control range from 0 to 100 Pa.

The air pressure control system is not compatible with constant flow control system.

OPTIONAL ACCESSORIES: B792 – 400/3+N/50 POWER SUPPLY**OPTIONAL ACCESSORIES: B794 – 230/1/60 POWER SUPPLY****OPTIONAL ACCESSORIES: B795 – 230/3/60 POWER SUPPLY****OPTIONAL ACCESSORIES: B796 – 380/3+N/60 POWER SUPPLY****OPTIONAL ACCESSORIES: B798 – 460/3+N/60 POWER SUPPLY****OPTIONAL ACCESSORIES: P091 – BACKUP MODULE CONTROLLER**

The optional is installed within the electrical panel.

The optional accessory is not compatible with "Plenum for free-cooling" and with "Steam humidifier" optional accessories.

The system guarantees the microprocessor power supply for a few minutes in case of supply voltage failure.

OPTIONAL ACCESSORIES: 383 – NUMBERED WIRINGS + UK REQUESTS

The machine's electrical cables are all numbered for easy identification. For the power section it is possible to change the colour for the UK market.

CABLE	383 – COLOUR FOR UK
EARTH	YELLOW / GREEN
NEUTRAL	BLUE SKY
PHASE 1 (L1)	BROWN
PHASE 2 (L2)	BLACK
PHASE 3 (L3)	GREY
AUXILIARIES	RED

OPTIONAL ACCESSORIES: A471 – SERIAL CARD RS485



The card is factory installed.
Consult the Interface Manual for all technical information.

OPTIONAL ACCESSORIES: A472 – SERIAL CARD RS232



The card is factory installed.
Consult the Interface Manual for all technical information.

OPTIONAL ACCESSORIES: A473 – ETHERNET CARD



The card is factory installed.
Consult the Interface Manual for all technical information.

OPTIONAL ACCESSORIES: A474 – SERIAL CARD LON



The card is factory installed.
The manufacturer will supply the serial card and .NXE file and a .XIF files necessary for LonWorks technicians to configure the network.
The board is programmed by the technician in charge of the integration.
Consult the Interface Manual for all technical information.

OPTIONAL ACCESSORIES: B811 - AIR FLOW LOSS ALARM



The system includes a differential pressure switch installed in the electrical panel or in the front compartment of the indoor unit and the plastic hoses for the relief of the pressure in fan mouth.

Control range: 0.2 ... 2.0 mbar (20 ... 200 Pa)
Differential for intervention: 0.1 mbar (10 Pa)
Supplied with the sensor set at fixed point of 0.2mbar, no availability to change it.

OPTIONAL ACCESSORIES: A381 - DRAIN PUMP



Not available for 380/3+N/60 and 460/3+N/60 power supply.
 The device is supplied in mounting kit.
 A plastic case contains the vertical type pump, the water tank with float plus safety switch and hydraulic and electric connection.
 Together the pump 10 linear meters anti-crushing plastic discharge spiral tube is supplied
 The optional must be installed as shown in the documentation delivered together with the unit.
 Wiring includes power supply and an alarm, displayed on microprocessor, that includes motor pump thermal protection and tank overflow.
 The condensate discharge pump operation is fully automatic.

WARNING

For all the machines the optional accessory is supplied in mounting kit.

TECHNICAL DATA

Power supply: 230V~ 50Hz
 Electrical data: 70W – 0,67A
 Maximum water flow: 500 l/h
 Maximum delivery height: 5.0 m
 Sound level: 45dBA a 1 m
 Maximum water temperature: 70°C
 Water acidity: pH>2.5
 Tray volume: 2.0 l
 Protection IP 20
 Dimensions: 279 x 130 x 171h (mm)

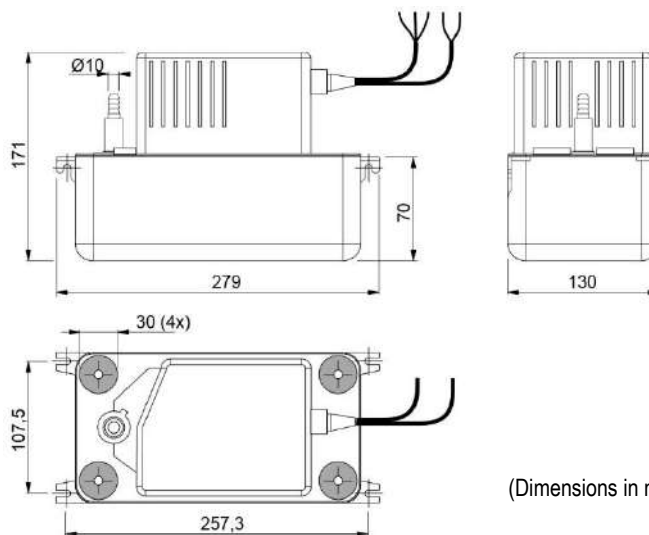

(Dimensions in millimetres)

Discharge head	Total length of discharge pipes (Ø 10 mm internal)			
	5m	10m	20m	30m
1m	380	300	240	190
2m	310	260	200	150
3m	240	200	145	110
4m	150	130	80	60
5m	30	20	0	0

OPTIONAL ACCESSORIES: A491 - WATER LEAKAGE DETECTOR



The system includes an electronic relay installed in the electrical panel of the indoor machine. The electrical connections for the probe and the alarm contact are present in the indoor machine's terminal board. Sensor is installed inside unit for Over/Displacement air flow version and supplied to be connected and installed at customer care for Under air flow units.

OPTIONAL ACCESSORIES: A492 – WATER LEAKAGE DETECTOR + ADDITIONAL SENSOR



The system includes an electronic relay installed in the electrical panel of the indoor machine and 2 water detectors to be connected in series. The electrical connections for the probe and the alarm contact are present in the indoor machine's terminal board. The first sensor is installed inside unit for Over/displacement air flow version. In Under air flow version are supplied to be connected and installed at customer care.

OPTIONAL ACCESSORIES: A501 - CLOGGED FILTERS



The system includes a differential pressure switch installed in the electrical panel or in the front compartment of the indoor unit and the plastic hoses for the relief of the pressure upstream and downstream the air filters.

Control range: 0.3 ... 4.0 mbar (30 ... 400 Pa)
Differential for intervention: 0.15 mbar (15 Pa)

OPTIONAL ACCESSORIES: A511 – SMOKE DETECTOR



The device is supplied in mounting kit. The optical smoke detector senses the presence of combustion by-products (visible smoke) and activates an alarm. The operating principle is based on the light scattering technique (Tyndall effect). The device is in conformity to EN 54-7 standard. Technical features:

Material	ABS	Relative humidity	<93% not-condensing
Power supply	12...28 Vdc	Index of protection	IP 20
Normal current	50µA 24 Vdc	Testing by magnet	Yes
Alarm current	25mA 24 Vdc	Relay	max. 1A 30Vdc
LED visibility	360° (double led)	Signal repeater	14mA 24 Vdc
Storage temperature	-10...+70°C	Covered area	40m² max.
Operating temperature	-10...+70°C	Shielded connection	Min. 0.5 mm²
Max. speed air	0.2 m/s	Colour	White

Supplied as optional with unit to be connected and installed at customer care close to the unit.

OPTIONAL ACCESSORIES: A521 – FIRE DETECTOR



The device is supplied in mounting kit. The fire detector has been designed to identify temperatures at which fires may start. When the temperature exceeds the set threshold or when there is a rapid variation in temperature, the relay is activated to signal an alarm. The device is in conformity to EN 54-5 standard. Technical features:

Material	ABS	Index of protection	IP 20
Power supply	12...28 Vdc	Testing by magnet	Yes
Normal current	50µA 24 Vdc	Relay	max. 1A 30Vdc
Alarm current	25mA 24 Vdc	Signal repeater	14mA - 24 Vdc
LED visibility	360° (double LED)	Alarm temperature	62°C
Storage temperature	-10...+70°C	Covered area	40m² max.
Operating temperature	-10...+70°C	Shielded connection	Min. 0.5 mm²
Relative humidity	<93% non-condensing	Colour	White

Supplied as optional with unit to be connected and installed at customer care close to the unit.

OPTIONAL ACCESSORIES: 5891 – CONTROL UNIT VIA KIPLINK

The optional is factory installed.

KIPLink is an innovative system based on Wi-Fi technology that allows to operate on a unit directly from Smartphone or Tablet via an APP.



Logos, Trademarks and Company Name, are property of the respective Owners.

WI-FI MODULE:

- Standard: IEEE 802.11n – 802.11g
- Frequencies: 2.4 – 2.4835 GHz
- Output power: <20 dBm (equivalent to <100mW)
- Safety: WPA2
- Flow: < 20m

MEHITS APP

- Operating System: Android 5® or higher, IOS 8® or higher, Windows 10® or higher
- Download: Google Play®, Apple Store® e Microsoft Store®.

HOW TO USE KIPLINK

KIPLink can be used in three ways:

Proximity keyboard: Approaching the machine with a Smartphone or a Tablet with the MEHITS APP installed, you can connect to the machine via Wi-Fi and you can control it like the standard controller keyboard. It is possible to switch off / on the machine, change sets and reset alarms. Knowing the relative passwords, you access the parameters of the USER, SERVICE and MANUFACTURER menus.

Local Monitoring: Using a Smartphone, a Tablet or PC connected to the LAN of the building where the machine is also connected. Access is via WEB via a browser. The system has two access profiles: ONLY READ and READ & WRITE. ONLY READ allows only the visualization of the parameters and it is not possible to control the unit.

READ & WRITE allows you to switch off / on the machine, change sets and reset alarms. Knowing the relative passwords, you access the parameters of the USER, SERVICE and MANUFACTURER menus.

Remote monitoring: Using a Smartphone, Tablet or PC connected to the VPN of the building where the machine is also connected, it is possible to operate and control from any geographical location where there is an internet connection. Use a secure VPN to avoid access by third parties that could compromise the operation of the machine. The cyber security is in charge of costumer.

DATA STORE

The system can store some data on a 1GB MicroSD card to be installed on the device. The data can be used for Service diagnostics. The card is not provided.

KIPLINK NETWORK

It is possible to set up mixed networks consisting of several KIPLink devices (10 maximum), to display information from different devices (called Client KIPLink) on one single device (called Master KIPLink). The information is collected from the various Client KIPLink devices connected to EVOLUTION+ / W3000 TE/ CX-4 controllers and sent through the Wi-Fi or Ethernet network to the Master KIPLink device, which stores them and makes them available through an appropriate user interface.

The connection with the Master KIPLink can take place via Wi-Fi, via Ethernet or a combination of the two. For complete information on the KIPLink system, please consult the relative technical documentation.

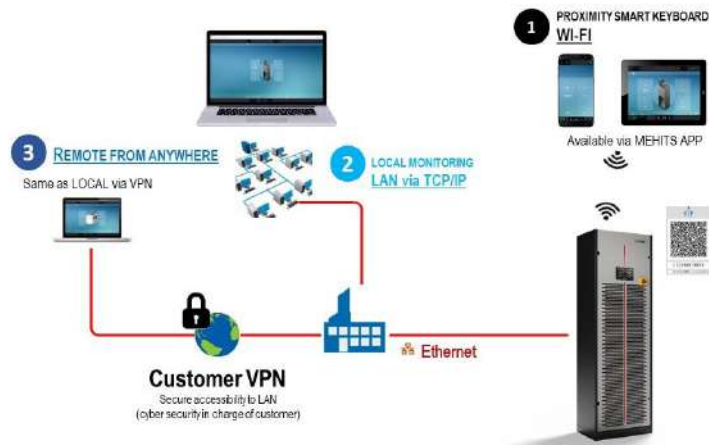

OPTIONAL ACCESSORIES: A35B – GRAPHIC DISPLAY “Evolution Touch”



The optional is factory installed.
 7” touch-screen graphic display with 16.7 million colors for the management and monitoring of operating and alarm status.
 The Display is equipped with a MicroUSB 2.0 port for the service connection.

The navigation bars are always present on the display to allow quick and intuitive navigation.

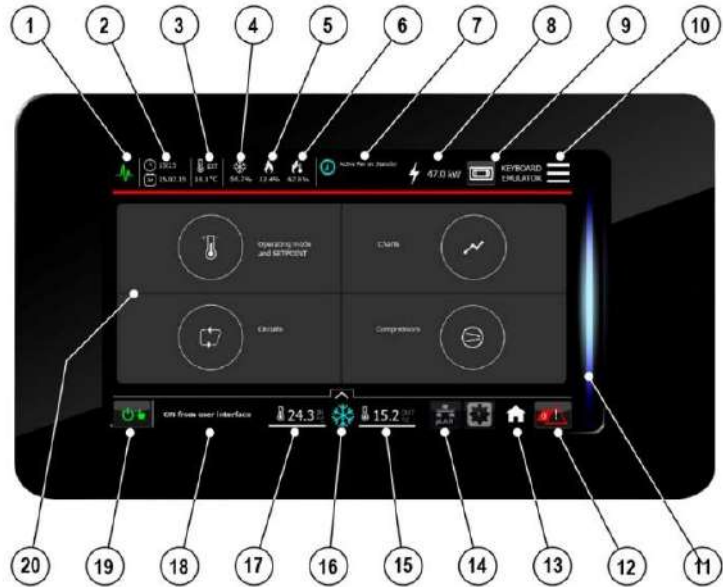

TOP NAVIGATION BAR

1. Status of connection with the controller. Green: connection OK; Red: connection Error
2. Time and date
3. External temperature value by dedicated probe
4. Active percentage of Cooling
5. Active percentage of Heating
6. Active percentage of Post-Heating
7. Unit active functions
8. Power meter readings
9. PGD1 keyboard emulator
10. Rapid access to the menu (Quick menu)

BOTTOM NAVIGATION BAR

11. Light bar for machine status identification
12. Alarm button to access the alarm management screen and the number of active alarms
13. Home button for returning to the Homepage
14. pLAN network
15. Temperature of outlet air or percentage of humidity.
16. Operating mode button.
17. Inlet air temperature
18. Unit status
19. On/Off button

DISPLAY AREA

20. Main menu
 - a. Operating mode and Set-Point
 - b. Circuits
 - c. Charts
 - d. Compressors

For complete information on Graphic Display system, please consult the relative technical documentation.

OPTIONAL ACCESSORIES: A352 - NO DISPLAY

The unit is supplied without display and adjustment is only possible with the KipLink accessory.

OPTIONAL ACCESSORIES: A822 – ADAPTIVE SET-POINT



ADAPTIVE SET-POINT

An advanced algorithm that instantaneously detects the real thermal load of the indoor units and then conveys this information to the outdoor chillers, strongly increasing their operation.

- Dynamic variation of the chillers set point and water flow.
- Increasing of the free cooling mode.
- Adoption of the active redundancy system to better exploit stand-by chillers.

OPTIONAL ACCESSORIES: P141 – ANALOGUE SET-POINT COMPENSATION

Analogue set point compensation according to an external analogue signal at Customer care. The microprocessor control, through the additional module "expansion card", can manage a compensation signal of the return air setpoint by analogue input (0...1V; 0...5V; 0.5...4.5V; 4...20mA; 0...20mA). The compensation curve allows to assign a temperature setpoint offset respectively to the minimum and maximum signal managed by the input.

OPTIONAL ACCESSORIES: A842 - NETWORK ANALYZER



The optional is supplied in kit for external installation to the machine, and includes:

- Main switch with door lock safety.
- Fuse.
- Network transducer.
- Current transformers, one for each power supply phase cable.
- Terminals.

This device provides continuous measurement of power consumption, monitoring current, voltage and power. These values are sent to unit microprocessor via RS485 serial cable, as shown on the unit wiring diagram.

The displayed variables are:

- Phase to phase voltage, only for three-phase units.
- Phase voltage (phase-neutral).
- Phase current.
- Neutral current only for three-phase units.
- Active phase power, only for three-phase units.
- Total active power.
- Active energy.
- Hour counts.

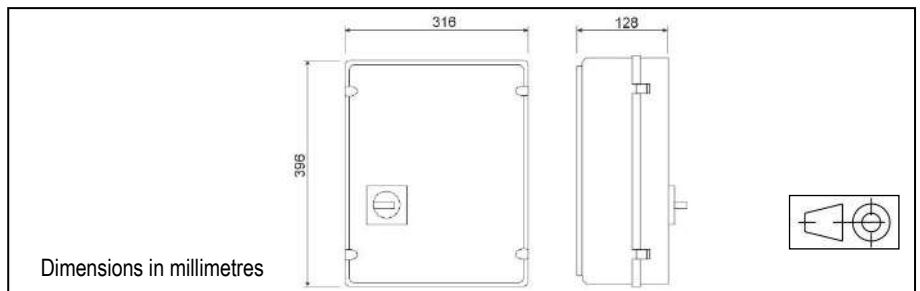

Wall-mounting fixing screws not supplied
 Weight of the system: 5 kg
 Electrical connections at Customer care

OPTIONAL ACCESSORIES: A812 – FREE-COOLING DIRECT CONTROL

Not available for Over (O) version.
 Preparation of the machine and the electrical panel for the direct free-cooling system "P034 Intake free-cooling plenum".

OPTIONAL ACCESSORIES: A791 – AIR TEMPERATURE CONTROL ON AIR RETURN

Preparation of the machine for the control of the ambient air temperature with probes on air intake.

OPTIONAL ACCESSORIES: B803 – 0-10V 3-WAY VALVE



Optional accessory of the cooling coil; replace the 2-way valve.
 3-way modulating motorized valve with 0÷10 VDC control actuator and emergency manual control.
 The optional accessory is factory installed and don't modify the overall dimensions of the unit.
 This type of valve offers the following series of benefits:

- Equal percentage flow control.
- No peaks initial flow.
- Excellent stability control thanks to the integrated characterizing disc.
- Excellent characteristic in partialisation.
- Stability in control.
- Maintenance free.
- Self-cleaning.

CHARACTERISTICS OF THE 3-WAY BALL VALVE

- Control path leakage rate A, air bubble-tight (EN 12266-1), bypass leakage rate I (EN 1349 e EN 60534-4).
- Maximum fluid pressure $P_s=1600\text{kPa}$.
- Maximum closing pressure (Close-off) $\Delta P_s=1400\text{kPa}$.
- Maximum differential pressure $\Delta P_{max}=200\text{kPa}$.

The rotary actuator is controlled by a 0 ... 10 VDC signal and is optimized for this type of valve. The valve opens by turning counterclockwise and closes by turning clockwise. The actuator is equipped with a button for manual emergency operation and is maintenance-free.

VERSION (1)	U / O / DL	U / O / DL	U / O / DL	U / O / DL	U / O / DL	U / O / DL	U / O / DL
MODEL	006	009	011	013	016	022	026
SIZE	F1	F1	F1	F1	F2	F2	F2
3-VIE VALVE							
k_v – Flow coefficient	m^3/h	2.5	2.5	4.0	4.0	6.3	6.3

1. U = Under, downflow / O = Over, upflow / DL = Displacement

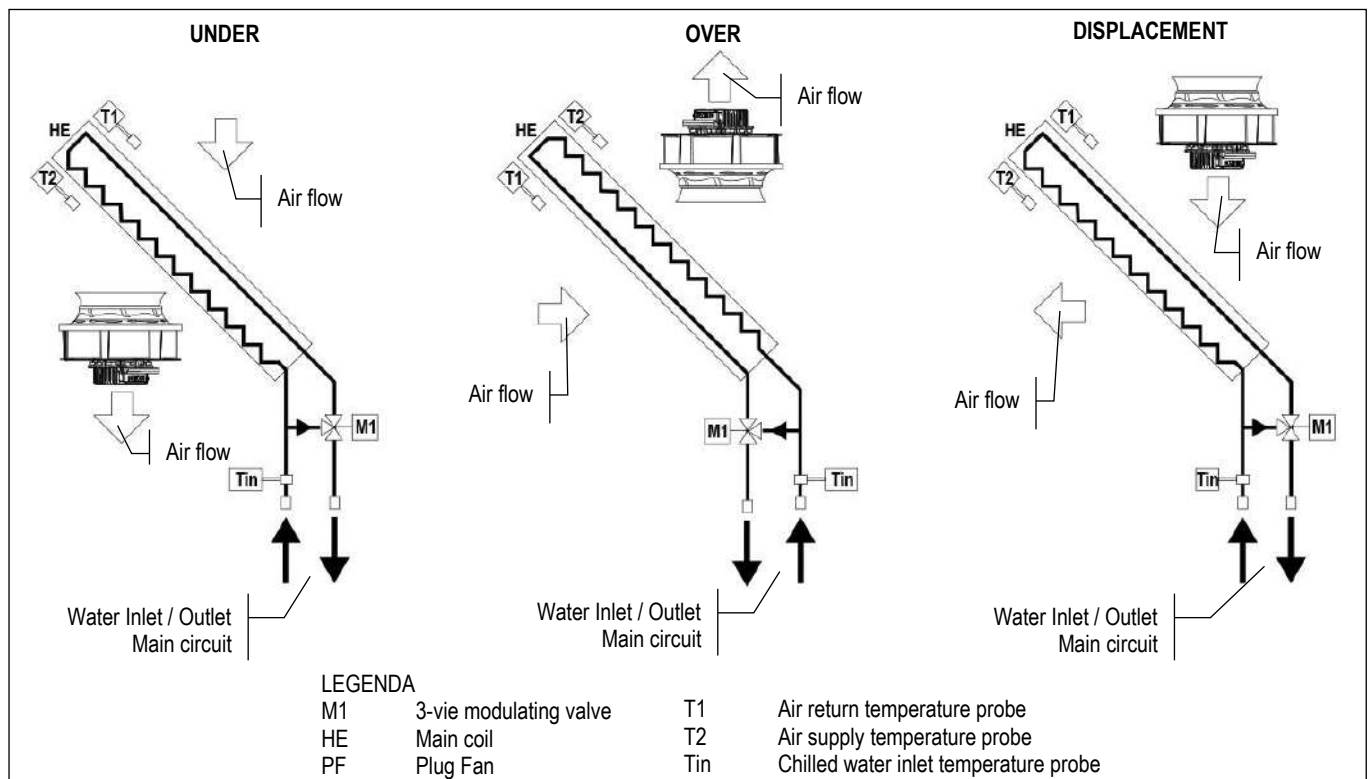

IMPORTANT

For further information, please refer to chapter “VALVE PRESSURE DROP CALCULATION AS FUNCTION OF WATER FLOW RATE”.

OPTIONAL ACCESSORIES: B807 - EPIV 2-WAY VALVE



Not available for Displacement (DL) version.
 Optional accessory of the cooling coil and replace the 2-way valve.
 It is not possible to combine the EPIV valve with "P131 – HOT WATER COIL + 2WAY VALVE".
 Pressure independent regulating EPIV valve with electronic flow control.
 The optional accessory is factory installed and don't modify the overall dimensions of the unit.

This type of valve offers the following series of benefits:

- Equal percentage flow control and integrated characterizing disc.
- Excellent stability control regardless of pressure variations and under all load conditions.
- Maintenance free.
- Self-cleaning.

CHARACTERISTICS OF THE EPIV VALVE

- Control path leakage rate A (EN 12266-1).
- Maximum fluid pressure $P_s=1600\text{kPa}$.
- Maximum closing pressure (Close-off) $\Delta P_s=1400\text{kPa}$.
- Maximum differential pressure $\Delta P_{max}=350\text{ kPa}$.

The rotary actuator is controlled by a 0 ... 10 VDC signal and is optimized for this type of valve. The valve opens by turning counterclockwise and closes by turning clockwise. The actuator is equipped with a button for manual emergency operation and is maintenance-free.

TECHNICAL DATA

Technical data referred to nominal working conditions:

- ambient air 26°C-40% RH.
- chilled water temperature 10-15°C - 0% glycol.

For different operating conditions, contact the manufacturer's sales office.

VERSION (1)		U / O	U / O	U / O	U / O	U / O	U / O	U / O
MODEL		006	009	011	013	016	022	026
SIZE		F1	F1	F1	F1	F2	F2	F2
EPIV VALVE								
K_{vs} theor. – Theoretical flow coefficient	m ³ /h	4.9	4.9	4.9	8.6	14.2	14.2	14.2
Flow rate (2)	l/min	13.6	22.6	27.7	35.8	44.1	58.5	73.4
Max flow rate	l/min	39	39	39	69	108	108	108

1. U = Under, downflow / O = Over, upflow
2. Flow rate at ambient air conditions 26 ° C-40% RH; with chilled water 10-15 ° C - 0% glycol.

OPTIONAL ACCESSORIES: P131 – HOT WATER COIL + 2WAY VALVE



Not available for Displacement (DL) version.

Not available for model 013 and 026.

It is not possible to combine the hot water coil with "B807 EPIV 2-WAY VALVE".

The optional accessory is factory installed and don't modify the overall dimensions of the unit.

Hot water heating system installed downstream the main cooling coil.

Components:

- Heat exchanger coil with copper tubes and high efficiency aluminium fins, specifically developed to provide high heat transfer and lower pressure drops.
- 2-way motorized valve for water flow regulation with 0÷10 VDC control actuator and emergency manual control.
- Temperature probe on water inlet.
- Frame in galvanized steel.

The hot water heating system can be installed in combination with the "A431 electric heater". The operation is alternate with priority to the hot water heating coil.

For the water quality of the heating circuit, please refer to the chapter "WATER QUALITY OF THE HYDRAULIC CIRCUITS".

Temperature control on suction air.

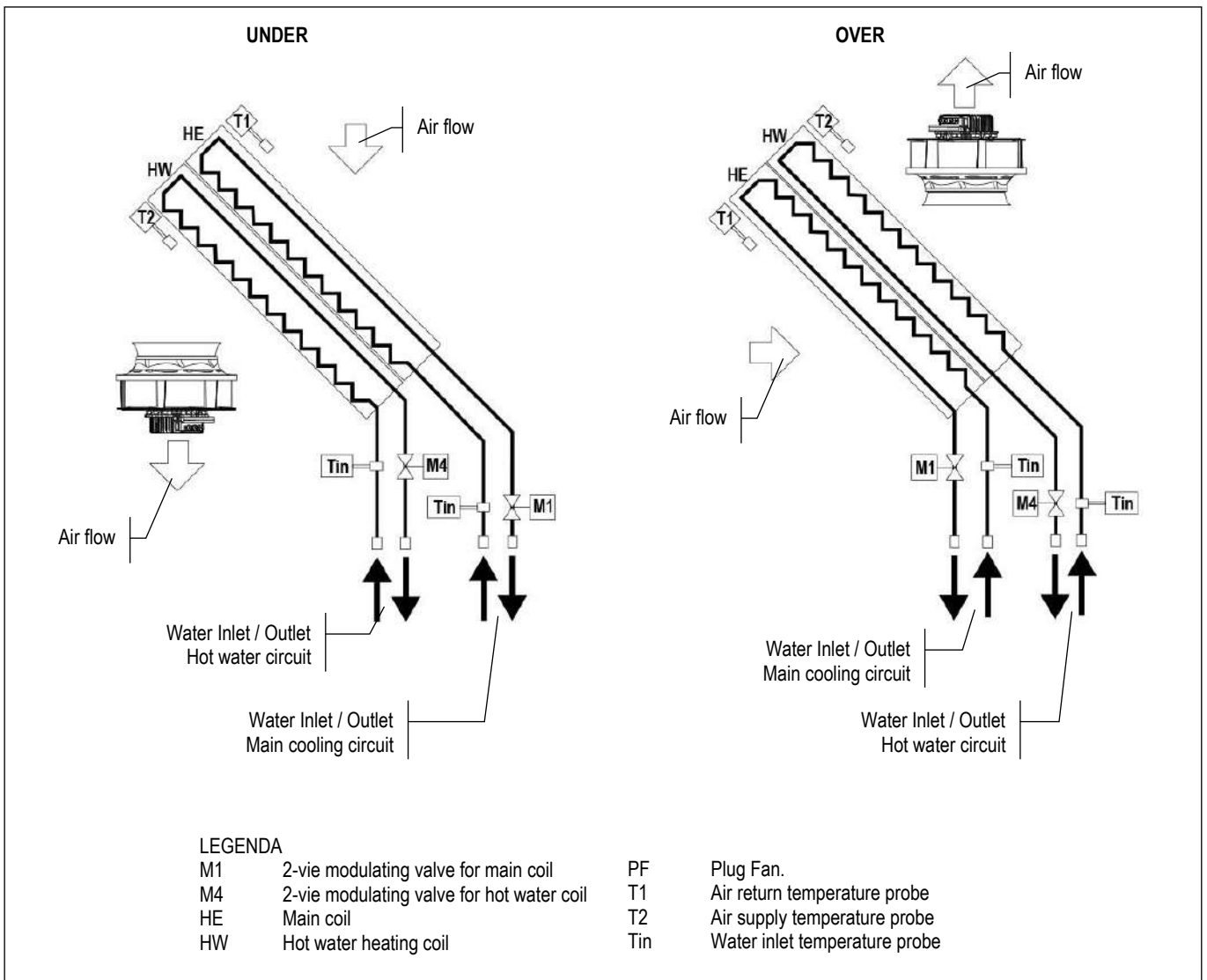

TECHNICAL DATA

VERSION (1)		U / O	U / O	U / O	U / O	U / O	U / O	U / O
MODEL		006	009	011	013	016	022	026
SIZE		F1	F1	F1	F1	F2	F2	F2
THERMAL CAPACITY (2)	kW	7.97	10.1	10.9	--	20.8	22.8	--
HEATING COIL								
Water flow rate (2)	m ³ /h	0.70	0.89	0.96	--	1.83	2.01	--
dP coil + valve (2)	kPa	9.31	14.3	16.7	--	30.6	36.6	--
Water content	l	0.9	0.9	0.9	--	1.6	1.6	--
NET WEIGHT (3)	kg	3.3	3.3	3.3	--	6.3	6.3	--
HYDRAULIC CONNECTIONS								
Water Inlet / Outlet ISO 7/1 - R	Ø	3/4"	3/4"	3/4"	--	1"	1"	--

1. U = Under, downflow / O = Over, upflow
2. Characteristics referred to entering air at 20°C-50%UR with hot water temperature 70/60°C - 0% glycol.
3. Value to be added to the weight of the standard unit. Does not include the weight of the water content.

2-WAY BALL VALVE FOR HOT WATER FLOW CONTROL



The water flow control in the finned coil is achieved through a **2-way modulating ball valve with equal percentage flow control** ensured by the integrated characterizing disc.

This type of valve offers the following series of benefits:

- Equal percentage flow control.
- No peaks initial flow.
- Excellent stability control thanks to the integrated characterizing disc.
- Excellent characteristic in partialisation.
- Stability in control.
- Maintenance free.
- Self-cleaning.

CHARACTERISTICS OF THE 2-WAY BALL VALVE

- Closing seal with leakage rate in Class A (EN 12266-1).
- Maximum fluid pressure $P_s=1600\text{kPa}$.
- Maximum closing pressure (Close-off) $\Delta P_s=1400\text{kPa}$.

The rotative actuator is controlled by a signal 0 ... 10VDC from the microprocessor controller. The actuator is equipped with an emergency button for manual operation and is maintenance-free.

OPTIONAL ACCESSORIES: A431 - ELECTRIC HEATERS



Not available for 460/3+N/60 power supply.

Electric heater consisting of finned aluminum elements, ensuring low surface temperature and deleting the air ionization problems. The optional is installed downstream the main cooling coil.

The electric heating system can be installed in combination with the "P131 hot water coil + 2-way valve".

The operation is alternate with priority to the hot water heating coil.

In electric heaters with three working steps the activation is binary type.

Components:

- Electric heater in aluminium armoured elements with integral fins.
- Electrical control.
- Safety thermostat.

230/1/50-60 POWER SUPPLY

SIZE		F1	F2
VERSION (1)		U / O / DL	U / O / DL
THERMAL CAPACITY	kW	2.6	3.9
Power supply	V/Ph/Hz	230/1/50-60	230/1/50-60
Max absorbed current (FLA)	A	11.3	16.9
First working step	kW	1.3	1.3
Second working step	kW	1.3	2.6
Third working step	kW	---	1.3 + 2.6
NET WEIGHT (2)	kg	5	10

400/3+N/50 POWER SUPPLY

SIZE		F1	F2
VERSION (1)		U / O / DL	U / O / DL
THERMAL CAPACITY	kW	2.6	3.9
Power supply	V/Ph/Hz	400/3+N/50	400/3+N/50
Max absorbed current (FLA)	A	11.3	16.9
First working step	kW	1.3	1.3
Second working step	kW	1.3	2.6
Third working step	kW	---	1.3 + 2.6
NET WEIGHT (2)	kg	5	10

230/3/60 POWER SUPPLY

SIZE		F1	F2
VERSION (1)		U / O / DL	U / O / DL
THERMAL CAPACITY	kW	2.6	3.9
Power supply	V/Ph/Hz	230/3/60	230/3/60
Max absorbed current (FLA)	A	11.3	16.9
First working step	kW	1.3	1.3
Second working step	kW	1.3	2.6
Third working step	kW	---	1.3 + 2.6
NET WEIGHT (2)	kg	5	10

380/3+N/60 POWER SUPPLY

SIZE		F1	F2
VERSION (1)		U / O / DL	U / O / DL
THERMAL CAPACITY	kW	2.4	3.6
Power supply	V/Ph/Hz	380/3+N/60	380/3+N/60
Max absorbed current (FLA)	A	10.8	16.2
First working step	kW	1.2	1.2
Second working step	kW	1.2	2.4
Third working step	kW	---	1.2 + 2.4
NET WEIGHT (2)	kg	5	10

1. U = Under, downflow / O = Over, upflo / DL Displacement.
2. Value to be added to the weight of the standard unit.

OPTIONAL ACCESSORIES: 4301 – STEAM HUMIDIFIER



Humidifier control board

Modulating steam humidifier with immersed electrodes fitted with safety and running accessories. A metallic cover on the top and tank ensure the highest levels of safety during operation. Standard for safety flammability UL94: V0.

The optional includes the combined temperature / humidity sensor on unit air intake and control board. The accessory is factory installed and requires only water filling connection.

Humidifier water charge and discharge pipes are not supplied.

It is recommended to install a filter and a shut-off valve on water inlet pipe.

This humidifier produces non-pressurized steam by electrodes immersed in the water inside the cylinder: they bring the electric phase in the water that works as an electrical resistance and overheats. The steam so produced is distributed with dedicated distributors and used for ambient humidification or for industrial processes.

CHARACTERISTICS OF THE SUPPLY WATER

The quality of the used water influences the evaporation process, so the humidifier can be fed with **not-treated water, only when potable and non-demineralised.**

LIMIT VALUES

		Min	Max
Hydrogen ions	pH	7	8.5
Specific conductivity at 20°C	$\sigma_{R, 20^\circ C}$ $\mu S/cm$	350	750
Total dissolved solids	TDS mg/l	(1)	(1)
Dry residue at 180°C	R ₁₈₀ mg/l	(1)	(1)
Total hardness	TH mg/l CaCO ₃	100 (2)	400
Temporary hardness	mg/l CaCO ₃	60 (3)	300
Iron + Manganese	mg/l Fe + Mn	0	0.2
Chlorides	ppm Cl	0	30
Silica	mg/l SiO ₂	0	20
Residual chlorine	mg/l Cl ⁻	0	0.2
Calcium sulphate	mg/l CaSO ₄	0	100
Metallic impurities	mg/l	0	0
Solvents, diluents, soaps, lubricants	mg/l	0	0

(1) Values depending on specific conductivity; in general: TDS \cong 0.93 * $\sigma_{R, 20^\circ C}$; R₁₈₀ \cong 0.65 * σ_R

(2) Not lower than 200% of the chloride content in mg/l di Cl⁻

(3) Not lower than 300% of the chloride content in mg/l di Cl⁻

WARNING:

- Use only with drinking water.
- There is no reliable relationship between hardness and water conductivity.
- Do not treat water with softeners! This could cause corrosion of the electrodes or the formation of foam, leading to potential operating problems or failures.
- Do not add disinfectants or corrosion inhibitors to water, as these substances are potentially irritant.
- Is absolutely forbidden to use well water, industrial water or water drawn from cooling circuits; in general, avoid using potentially contaminated water, either from a chemical or bacteriological point of view.

SIZE		F1	F2
VERSION (1)		U / O / DL	U / O / DL
STEAM PRODUCTION	kg/h	3.0	3.0
Water content	l	3.9	3.9
Max water supply pressure	Bar	1÷8	1÷8
NET WEIGHT (2)	kg	4	4
HYDRAULIC CONNECTIONS			
WATER INLET - ISO 228/1 – G M	Ø	3/4"	3/4"

1. U = Under, downflow / O = Over, upflow / DL = Displacement air flow
2. Value to be added to the weight of the standard unit. Does not include the weight of the water content.

HUMIDIFIER ELECTRIC DATA

230/1/50-60 POWER SUPPLY

SIZE		F1	F2
VERSION (1)		U / O / DL	U / O / DL
Power supply	V/Ph/Hz	230/1/50-60	230/1/50-60
Power input	kW	2.3	2.3
Absorbed current (OA)	A	10.0	10.0
Max absorbed current (FLA)	A	14.1	14.1

400/3+N/50 POWER SUPPLY

SIZE		F1	F2
VERSION (1)		U / O / DL	U / O / DL
Power supply	V/Ph/Hz	400/3+N/50	400/3+N/50
Power input	kW	2.3	2.3
Absorbed current (OA)	A	10.0	10.0
Max absorbed current (FLA)	A	14.1	14.1

230/3/60 POWER SUPPLY

SIZE		F1	F2
VERSION (1)		U / O / DL	U / O / DL
Power supply	V/Ph/Hz	230/3/60	230/3/60
Power input	kW	2.3	2.3
Absorbed current (OA)	A	10.0	10.0
Max absorbed current (FLA)	A	14.1	14.1

380/3+N/60 POWER SUPPLY

SIZE		F1	F2
VERSION (1)		U / O / DL	U / O / DL
Power supply	V/Ph/Hz	380/3+N/60	380/3+N/60
Power input	kW	2.3	2.3
Absorbed current (OA)	A	10.4	10.4
Max absorbed current (FLA)	A	14.6	14.6

460/3+N/60 POWER SUPPLY

SIZE		F1	F2
VERSION (1)		U / O / DL	U / O / DL
Power supply	V/Ph/Hz	460/3+N/60	460/3+N/60
Power input	kW	2.3	2.3
Absorbed current (OA)	A	2.9	2.9
Max absorbed current (FLA)	A	4.0	4.0

1. U = Under, downflow / O = Over, upflow / DL = Displacement air flow

OPTIONAL ACCESSORIES: P051 - DEHUMIDIFICATION

The system is automatic and checks for any increase in ambient humidity.

Components:

- Temperature / Humidity sensor on the air intake.
- Electronic control system of the dew point temperature for the combined intervention of cooling capacity and air flow.

OPTIONAL ACCESSORIES: P161 – T/rH AIR INTAKE SENSOR



The accessory replaces the temperature sensor installed on the air intake in the indoor unit.

The sensor is supplied with following option:

- Steam humidifier installation.
- Dehumidification system.
- Displaying of the relative humidity room value.

OPTIONAL ACCESSORIES: 4666 – EXTERNAL AIR PROBE



The probe must be installed protected against atmospheric agent and allows the displaying of the external air temperature.

The sensor is mandatorily required with following option:

- P034 Intake free-cooling plenum.

OPTIONAL ACCESSORIES: P071 / P072 / P073 / P074 - REMOTE T/RH PROBE



In addition to the on-board temperature probes, In addition to the on-board temperature probes, the unit's control can manage up to 4 remote T/RH probes (optional), to measure the return and the delivery air temperature in different positions.

Depending on the individual characteristics of the room and the cooling equipment, the customer can choose where to install the additional probes to achieve best measurement results (N. add. return probes + N. add. delivery probes ≤ 4).

The probes can be configured from the Service menu of the controller.

The probes that are enabled, contribute to the calculation of the return and delivery temperature used for capacity adjustment purposes.

The customer can choose between different types of calculation:

- Temperature of the first probe enabled
- Average temperature of the probes
- Highest temperature of the probes
- Lowest temperature of the probes.

Notes: if a probe is connected but not enabled, its measurement can still be read on the display and by the BMS, but it is not used to calculate the adjustment temperature. It is possible to disable the probe on the unit and use only the remote probes for capacity adjustment purpose.

- **P071:** One probe
- **P072:** Two probes
- **P073:** Three probes
- **P074:** Four probes

OPTIONAL ACCESSORIES: P113 - DUAL POWER SUPPLY

The optional is supplied in mounting kit and contained in polycarbonate box.

The motorised changeover automatically manage changeover between two power supply lines, or manually for emergency operations.

These devices are suitable for low voltage systems with interruption of the supply to the load during transfer.

The model supplied in the automatic version checks the source and switches over automatically, based on configurable parameters.

OPEN TRANSITION TYPE TRANSFER SWITCH WITH A MINIMUM INTERRUPTION OF THE SUPPLY DURING TRANSFER.

To maintain the microprocessor powered and avoid its restarts is mandatory to foresee the installation of the “temporary microprocessor power supply” optional accessory. The system guarantees the microprocessor power supply for a few minutes, in case of supply voltage failure.

The wall mounting kit includes a plastic enclosure with following dimensions:
SINGLE-PHASE system – IP55

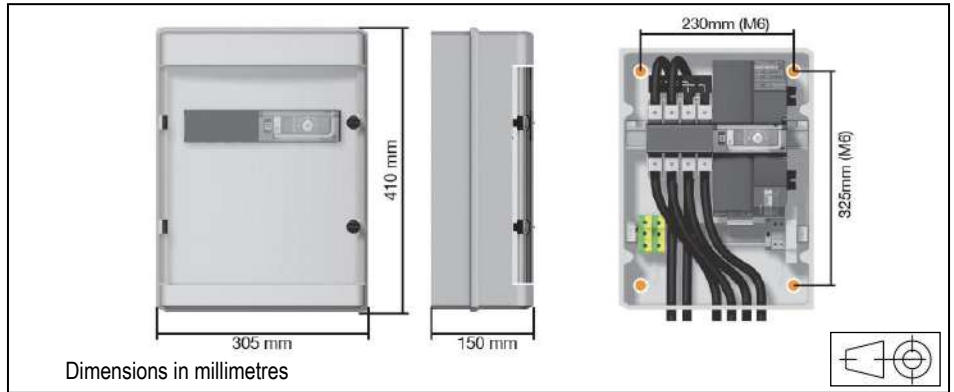

Wall-mounting fixing screws not supplied
Weight of the system: 12 kg
Electrical connections at Customer care

THREE-PHASES system – IP54

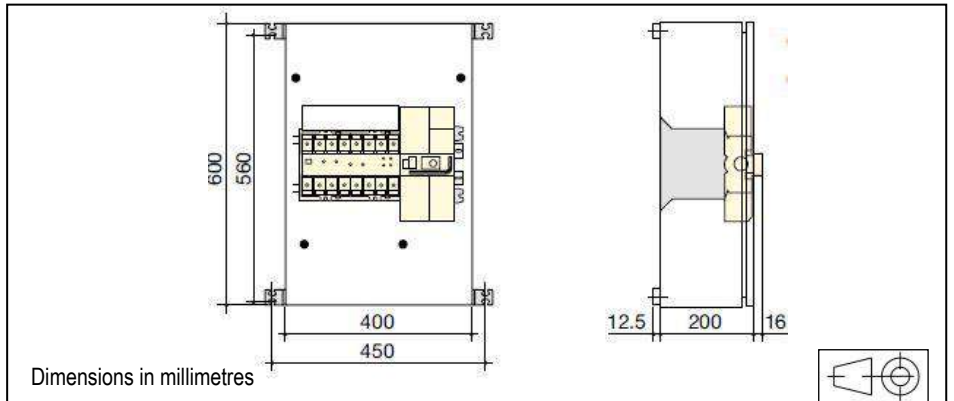

Wall-mounting fixing screws not supplied
Weight of the system: 12 kg
Electrical connections at Customer care

OPTIONAL ACCESSORIES: P084 – ePM₁₀ 50% AIR FILTERS

The ePM₁₀ 50% air filters (according to ISO EN 16890), replace the standard one.
The filters generate a pressure drops higher than the standard ones.
The filters are made of glass micro-fibre and are not regenerable.

MODEL		006	009	011	013	016	022	026
SIZE		F1	F1	F1	F1	F2	F2	F2
VERSION (1)		U / O	U / O	U / O	U / O	U / O	U / O	U / O
Additional pressure drops (2)	Pa	9	19	25	29	53	72	84
Reference air flow	m3/h	1500	2200	2500	2700	4300	5000	5400

MODEL		006	009	011	013	016	022	026
SIZE		F1	F1	F1	F1	F2	F2	F2
VERSION (1)		DL	DL	DL	DL	DL	DL	DL
Additional pressure drops (2)	Pa	4	10	12	12	26	35	35
Reference air flow	m3/h	1050	1540	1750	1750	3010	3500	3500

- U = Under, downflow / O = Over, upflow / DL = Displacement air flow
- Additional pressure drops referred to nominal air flow with clean filter.

OPTIONAL ACCESSORIES: A532 – DAMPER WITH SPRING RETURN

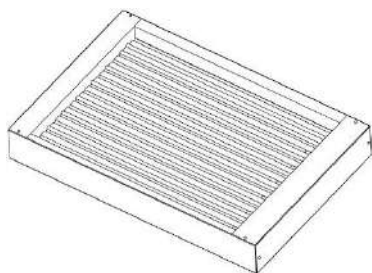

Not available for Displacement (DL) version.
 Accessory installed on unit air delivery (Over version) or return (Under version) and it can be matched to plenum.
 The optional is not suitable for installation in seismic areas.

FRAMEWORK

- Frame in galvanized steel sheet with protective surfaces treatment in compliance with UNI ISO 9227/ASTMB117 and ISO 7253, and painted with epoxy powders. Colour RAL 9005.
- Opposed blade dampers in galvanized steel sheet.
- Actuator for damper control with spring return.
- Terminals for electric connection to the unit.

WORKING LOGIC

The damper opens at supply fans activation to allow air flow.
 When the fans stop for failure or stop command, the damper closes, preventing air flow into the unit.

A532 OVER

A532 UNDER

SIZE	F1	F2
VERSION (1)	U / O	U / O
Weight (2) kg	9	12

1. U = Under, downflow / O = Over, upflow / DL = Displacement air flow
 2. Add this value to the total unit weight

OPTIONAL ACCESSORIES: P011 ... P034 - SUPPLY / INTAKE AIR PLENUM

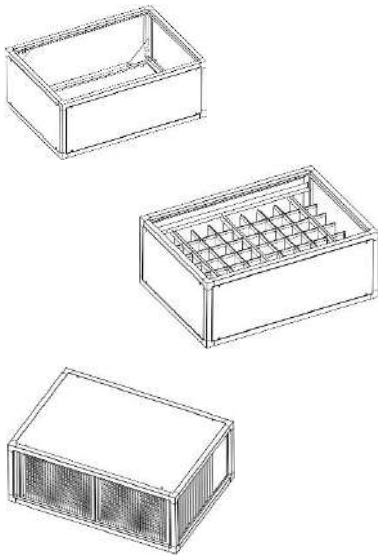

The optional is supplied separately and the installation on the unit is at Customer care. The plenums have same technical characteristics of the indoor unit cabinet.

It is possible to install only a single plenum to ensure stability to the unit. The optional are not suitable for installation in seismic areas.

FRAMEWORK

- Frame in aluminium extrusion, painted with epoxy powders. Colour RAL 7016.
- Panels in galvanized steel sheet with protective surfaces treatment in compliance with UNI ISO 9227/ASTMB117 and ISO 7253, and painted with epoxy powders. Colour RAL 7016.
- Panels insulated with polyurethane foam and seals to ensure airtight.
- Panels fixed with screws.
- Removable panels.
- Set of fixing elements to fasten the plenum to the unit.

Type of plenum:

- Empty supply/intake plenum. Also available with fire reaction in class "A1" (EN 13501-1).
- Plenum with frontal and lateral grilles. Also available with fire reaction in class "A1" (EN 13501-1) or reaction to fire classification.
- Plenum with soundproof sections.
- Plenum with frontal grille and soundproof sections.

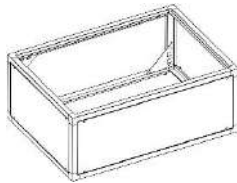

P011 / P012 – P031 / P032: EMPTY PLENUM

Not available for Displacement (DL) version. The plenum is void and can be used to rise the air inlet/outlet. Remove the frontal panels for inspection. Also available with fire reaction in class "A1" (EN 13501-1). The optional is not suitable for installation in seismic areas.

P011 / P012 OVER

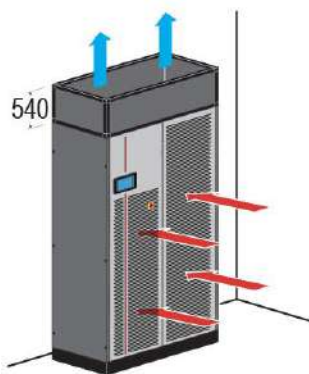

P031 / P032 UNDER

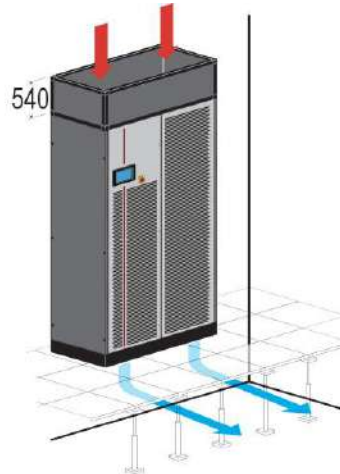

SIZE		F1	F2
VERSION (1)		U / O	U / O
Weight (2)	kg	12	16
Weight CL. A1 (2)	kg	22	29

1. U = Under, downflow / O = Over, upflow / DL = Displacement air flow
2. Add this value to the total unit weight

Dimensions in millimetres



P013 / P014: PLENUM + 3 GRILLES

Not available for Displacement (DL) version.

The plenum must be installed on air delivery.

The plenum allows the air distribution directly into the room.

The plenum is supplied with air distribution grilles with double row adjustable fins on front and lateral side.

Also available with fire reaction in class "A1" (EN 13501-1).

The optional is not suitable for installation in seismic areas.

P013 / P014 OVER

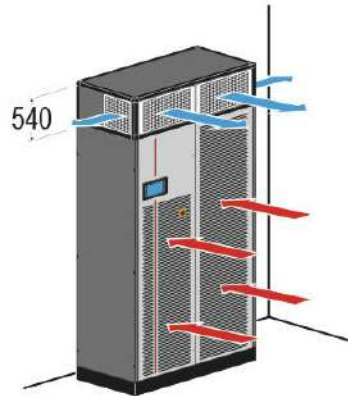

P013 / P014 UNDER

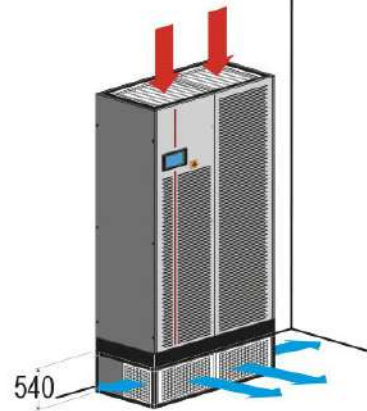

SIZE		F1	F2
VERSION (1)		U / O	U / O
Weight (2)	kg	12	16
Weight CL. A1 (2)	kg	17	22.5

1. U = Under, downflow / O = Over, upflow
2. Add this value to the total unit weight

Dimensions in millimetres

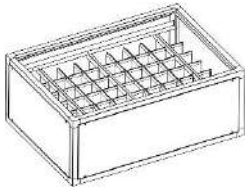

P015: SILENCED PLENUM

Not available for Displacement (DL) version.

The plenum must be installed on air delivery.

The plenum is fitted with sound absorbers to reduce the noise emission.

Remove the frontal panels for inspection.

The optional is not suitable for installation in seismic areas.

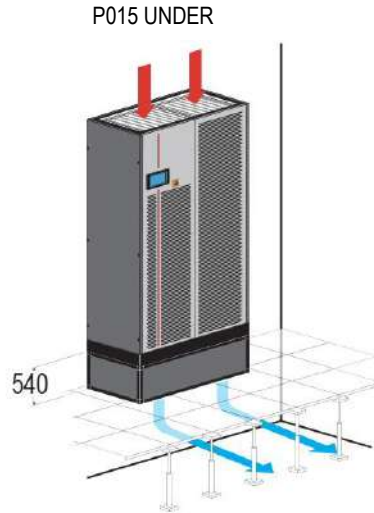
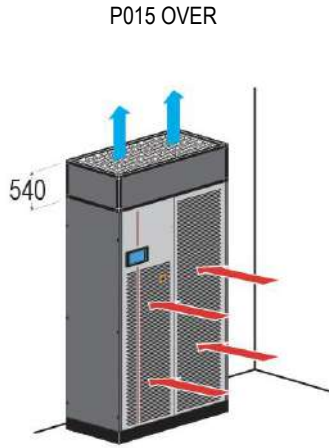

SIZE		F1	F2
VERSION (1)		U / O	U / O
Weight (2)	kg	18	24

1. U = Under, downflow / O = Over, upflow / DL = Displacement air flow
2. Add this value to the total unit weight

Dimensions in millimetres

ACOUSTIC DATA

MODEL		006	009	011	013	016	022	026
SIZE		F1	F1	F1	F1	F2	F2	F2
VERSION (1)		U / O	U / O	U / O	U / O	U / O	U / O	U / O
SOUND LEVEL ISO EN 3744 (2)								
On air delivery, Under (2)	dB(A)	45.9	59.9	61.9	63.9	56.1	63.1	65.1
On air delivery, Over (3)	dB(A)	45.9	59.9	61.9	63.9	56.1	63.1	65.1
Air flow (4)	m ³ /h	1500	2200	2500	2700	4300	5000	5400

1. U = Under, downflow / O = Over, upflow
2. Noise pressure level at 1 meter in free field – ISO 3744
3. Air intake from the front.
4. Nominal air flow with noise absorption partitions plenum installation and external static pressure 20 Pa.

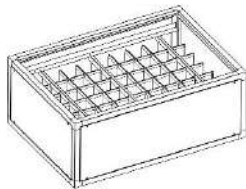

P033: SILENCED INTAKE PLENUM

Not available for Over (O) and Displacement (DL) version.
 The plenum is fitted with sound absorbers to reduce the noise emission.
 Remove the frontal panels for inspection.
 The optional is not suitable for installation in seismic areas.

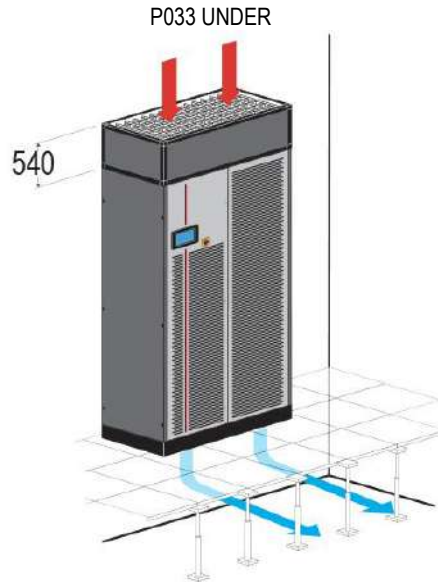

SIZE		F1	F2
VERSION (1)		U	U
Weight (2)	kg	18	24

1. U = Under, downflow
2. Add this value to the total unit weight

Dimensions in millimetres

ACOUSTIC DATA

MODEL		006	009	011	013	016	022	026
SIZE		F1	F1	F1	F1	F2	F2	F2
VERSION (1)		U	U	U	U	U	U	U
SOUND LEVEL ISO 3744 (2)								
On air intake, Under	dB(A)	41.7	55.7	57.7	59.7	52.0	59.0	61.0
Air flow (3)	m ³ /h	1500	2200	2500	2700	4300	5000	5400

1. U = Under, downflow
2. Noise pressure level at 1 meter in free field – ISO 3744.
3. Nominal air flow with noise absorption partitions plenum installation and external static pressure 20 Pa.

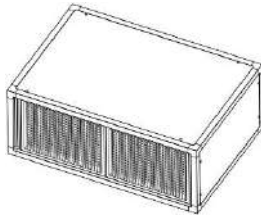

P016: SILENCED PLENUM + 1 GRILLE

Not available for Displacement (DL) version.

The plenum must be installed on air delivery.

The plenum allows the frontal air distribution directly into the room and a noise reduction of the air delivery.

The plenum is supplied with air distribution grille with double row adjustable grills on front side and sound absorbers.

The optional is not suitable for installation in seismic areas.

P016 OVER

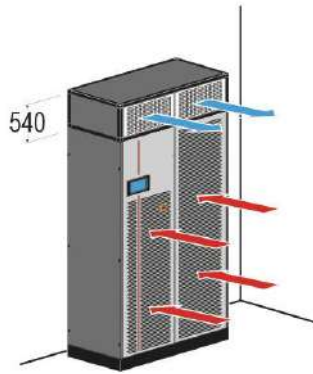

P016 UNDER

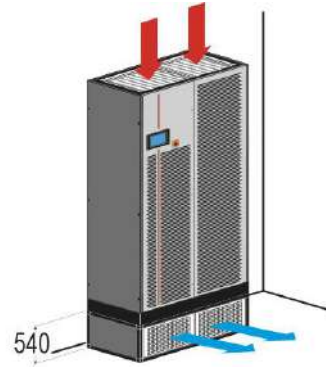

SIZE		F1	F2
VERSION (1)		U / O	U / O
Weight (2)	kg	12	16

1. U = Under, downflow / O = Over, upflow
2. Add this value to the total unit weight

Dimensions in millimetres

ACOUSTIC DATA

MODEL		006	009	011	013	016	022	026
SIZE		F1	F1	F1	F1	F2	F2	F2
VERSION (1)		U / O	U / O	U / O	U / O	U / O	U / O	U / O
SOUND LEVEL ISO 3744 (2)								
On air delivery, Under	dB(A)	44.5	58.5	60.5	62.5	54.9	61.9	63.9
On air delivery, Over	dB(A)	44.5	58.5	60.5	62.5	54.9	61.9	63.9
Air flow	m ³ /h	1500	2200	2500	2700	4300	5000	5400

1. U = Under, downflow / O = Over, upflow
2. Noise pressure level at 1 meter in free field – ISO 3744

OPTIONAL ACCESSORIES: P034 – INTAKE FREE-COOLING PLENUM

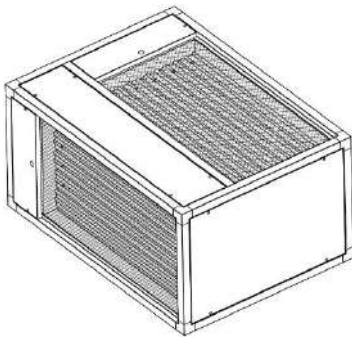

Expansion board of the microprocessor control

Not available for Over (O) version.

The optional is supplied separately and the installation on the unit is at Customer care.

The plenums have same technical characteristics and base dimensions of the machine cabinet.

The optional allow to obtain free-cooling by direct ambient air intake into the room.

The dampers are proportionally managed by the microprocessor control, that regulates the quantity of the ambient air to put in the room according to the set-point.

The optional is not suitable for installation in seismic areas.

COMPONENTS

- Frame in aluminium extrusion, painted with epoxy powders. Colour RAL 7016.
- Panels in galvanized steel sheet with protective surfaces treatment in compliance with UNI ISO 9227/ASTMB117 and ISO 7253, and painted with epoxy powders. Colour RAL 7016.
- Panels insulated with polyurethane foam and seals to ensure airtight.
- Removable panels fixed with screws.
- Opposed blade dampers in galvanized steel sheet and safety grille for ambient air and room air suction.
- Actuator for each damper.
- Terminals for electric connection to the unit.
- Set of fixing elements to fasten the plenum to the unit.
- Combined Temperature / Humidity sensor on machine air suction. The sensor must be moved outside the air conditioners for a proper read of the room temperature value.
- Temperature sensor for outdoor air. The sensor must be installed in the outdoor air suction duct or anyway protected against atmospheric agent.
- Expansion board for microprocessor control.
- Free contact for free-cooling operating status monitoring.
- Terminals on indoor unit for:
 - 24 Vac power supply for the overpressure damper servomotor.
 - 0-10Vdc control signal for the servomotor.
 Servomotor and overpressure damper are not supplied.

Ducting for ambient air suction are at Customer care.

A rain cover with grille on ambient air intake is recommended.

UNDER

DISPLACEMENT

Rain cover with grille (not supplied)

Duct (not supplied)

Size	F1	F2
VERSION (1)	U / DL	U / DL
Weight (2) kg	18	25

1. U = Under, downflow / DL = Displacement air flow

2. Add this value to the total unit weight

AIR EXHAUSTION DAMPER – Not supplied

WARNING

IT IS COMPULSORY TO INSTALL IN THE ROOM TO BE CONDITIONED A MOTORIZED DAMPER APPROPRIATELY DIMENSIONED FOR THE EXHAUSTION OF AIR FROM THE ROOM DURING FREE-COOLING OPERATION.

During free-cooling operation, the air conditioner supplies ambient air directly into the room, this causes an increase in air pressure inside the room.

The exhaust damper avoids the increase in pressure in the room.

The damper must be installed at the highest point of the room to exhaust excess hot air to the outside.

Install the damper if possible, in opposite position to air conditioner.

The damper is controlled by the modulating signal 0-10Vdc of the free-cooling control of the air conditioner. The 24Vac power supply of the servomotor and the 0-10Vdc free-cooling signal is available on the unit's electrical terminal block (see wiring diagram for connections).

Air exhaustion must be protected with a rain cover and a grille (at Customer care).

The electrical connection cables are not supplied.

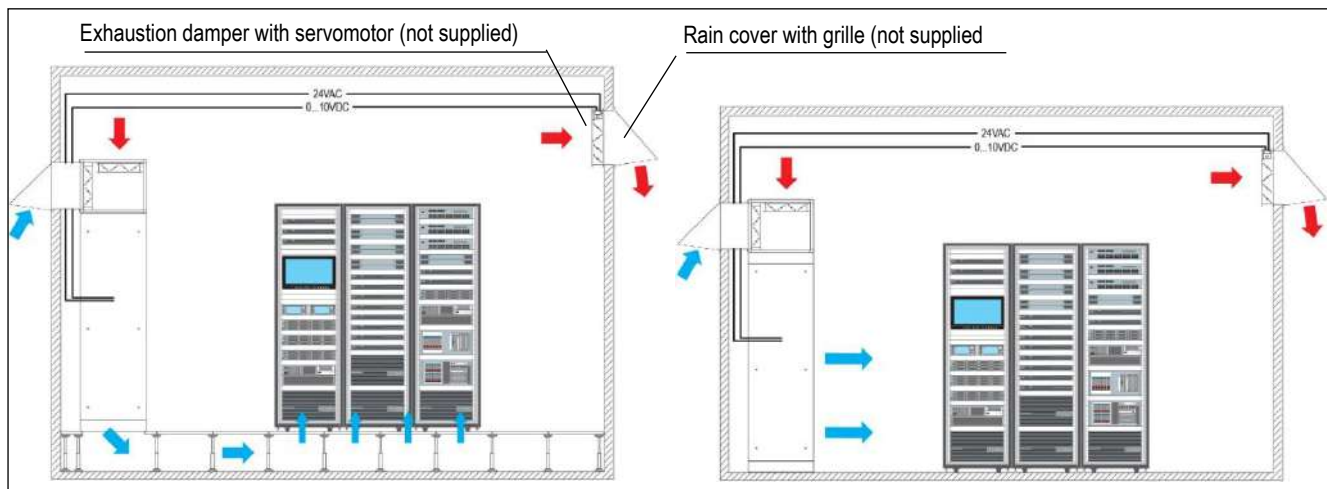

DIMENSIONS OF THE EXHAUSTION DAMPER

Unit model		006	009	011	013	016	022	026
Damper area	m ²	0.2	0.2	0.2	0.2	0.4	0.4	0.4
Air flow UNDER	m ³ /h	1500	2200	2500	2700	4300	5000	5400
Air flow DISPLACEMENT	m ³ /h	1050	1540	1750	1750	3010	3500	3500

In case of several units installed in the same room that operate simultaneously, it is possible to install a single damper with adequate section.

OPTIONAL ACCESSORIES: P041 / P042 / P043 - SUPPORT FRAME

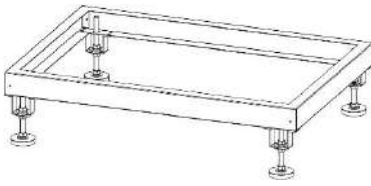

The optional is supplied in mounting kit.
 It is not possible to match the base frame with plenum installed under the machine.
 For a correct installation of the air conditioner we suggest you utilize a gasket between the base frame and the unit base.
 The base frame is available in 3 models with 3 different heights.
 The optional is not suitable for installation in seismic areas.

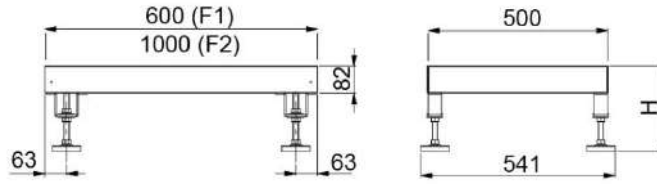

MODEL		Hmax350	Hmax450	Hmax510
Code		P041	P042	P043
H min. height	mm	255	355	400
H max. height	mm	350	450	510

1. U = Under, downflow / O = Over, upflow / DL = Displacement air flow

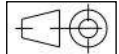

OPTIONAL ACCESSORIES: A272 – CL.A1 (EN13501-1) INSULATION

Not available for Displacement (DL) version.
 The optional is designed **TO SUPPLY THE PANELING ONLY WITH FIRE REACTION IN CLASS A1 (EN 13501-1)**¹⁾; furthermore, allows a noise insulation of the panels of the air conditioners.
 The pressure level reduction of the unit is about 2 dB(A). The reduction refers **ONLY** to the sound level radiated from the unit or in front of the unit. The noise level data on return and delivery air do not undergo reductions. The accessory includes:

- External part as standard panel.
- Internal part in galvanized steel sheet.
- The inside noise insulation with special soundproof material.

REACTION TO FIRE CLASSIFICATION

On Italian territory, the classification is per the D.M. of June 26, 1984 and subsequent amendments, providing for a sort in "Classes" from 0 (non-combustible material) to 5 (extremely flammable material). The EN 13501-1 regulation is ordered in classes from A1 (non-combustible material) to F (extremely flammable material).

A comparison of the classes is not possible because the methods and evaluation criteria are completely different. The comparison table below is being considered purely indicative.

Definition	Italian classes	EN 13501-1
Non-combustible material	Class 0	A1
Combustible material, very limited contribution to fire	Class 1	A2 – B
Combustible material, limited contribution to fire	Class 2	A2 – B - C
Combustible material, medium contribution to fire	Class 3	C – D
Combustible material, highly contribution to fire	Class 4	E
Combustible material, easily flammable	Class 5	F

It is possible to provide the sandwich panels for the OVER units with air flow from the top. This implies that the air intake must necessarily be from the base of the unit with front blind panelling (optional "B263 Bottom air intake + blind panels").
 The accessory increases the unit weight:

SIZE		F1	F2
OVER Weight increasing (1)	kg	26	35
UNDER Weight increasing (1)	kg	31	42

1. Add this value to the total unit weight

OPTIONAL ACCESSORIES: P151 – LOWERED DISPLAY FOR UNDER

For machines installed above the supply plenum.
The display / keypad on the front panel of the machine is installed lowered by about 50cm to facilitate consultation and use.

OPTIONAL ACCESSORIES: P101 - ANTI-SEISMIC FIXING KIT

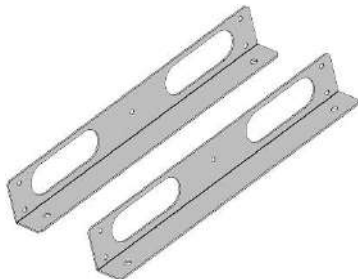

The optional is supplied in mounting kit.
Two lateral supports that must be fixed at the machine basement sides, supplied with fixing bolts.
This is a safety device that must be mounted before the unit installation and connected to a structural part with adequate resistance in the installation site to prevent the risk of unit movement or overturning due to earthquake.
Fixing screws to the structural part not supplied.

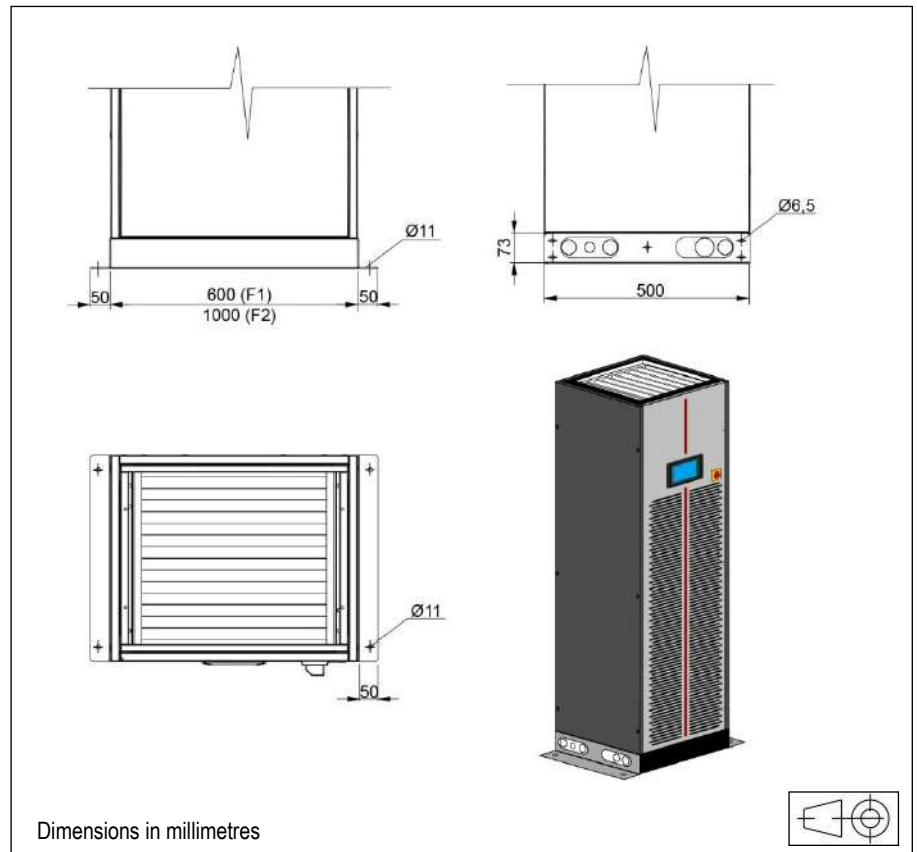

The fixing of the unit to the structure is at Customer care.
To grant anti-seismic resistance the unit must be fixed to a structural part with adequate resistance with 4 steel screws M10 (not supplied). Each anchoring system must resist to a lifting traction force as shown in table.

MODEL		006	009	011	013	016	022	026
SIZE		F1	F1	F1	F1	F2	F2	F2
VERSION (1)		U / O / DL	U / O / DL	U / O / DL	U / O / DL	U / O / DL	U / O / DL	U / O / DL
Number of screws	No.	4	4	4	4	4	4	4
Type of screw		M10	M10	M10	M10	M10	M10	M10
Traction resistance needed, single anchor, Under	kg	1007	1007	1007	1007	1503	1503	1503
Traction resistance needed, single anchor, Over	kg	1060	1060	1060	1060	1631	1631	1631
Traction resistance needed, single anchor, Displacement	kg	1212	1212	1212	1212	1789	1789	1789

1. U = Under, downflow / O = Over, upflow / DL = Displacement air flow

OPTIONAL ACCESSORIES: T500000310 / 311 - CONDENSATE TRAY (only UNDER version)

Additional condensing tray for Under flow version in peraluman.
This component must be considered as a safety device to install in the floor under the unit in the event of water leaks.
The water leakage sensor is supplied to be installed at customer care in the additional condensing tray.
The tray is equipped with a water drainage system Ø 22mm.

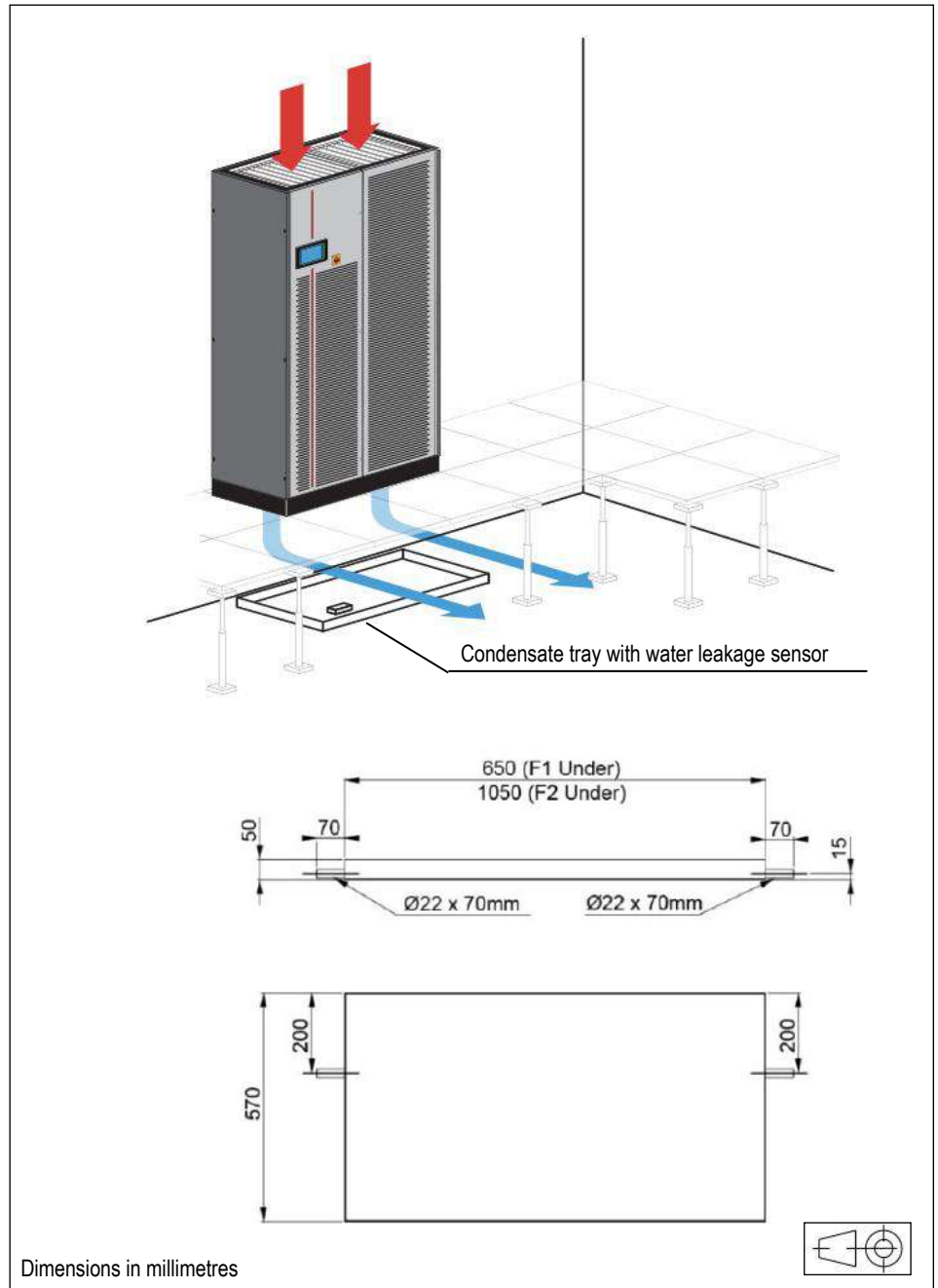

OPTIONAL ACCESSORIES: LM8300023 / 54 - UNIT BIND BRACKET



The bracket is supplied in mounting kit.
This bracket is supplied complete with fixing bolts to the machine.
This is a safety device that must be installed together with the unit and connected to a structural part in the installation site (wall, structure, etc.) to prevent the risk of unit overturning due to external causes (accidental impact, earthquake, etc.).
Wall fixing screws not supplied.

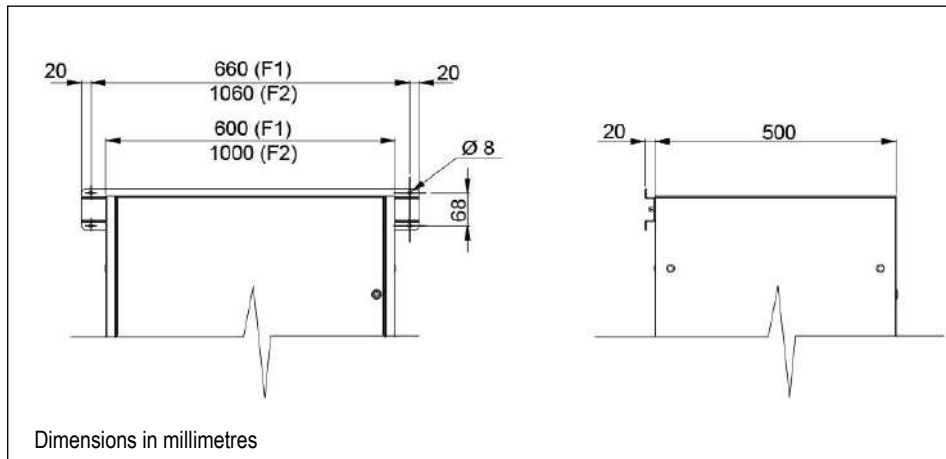

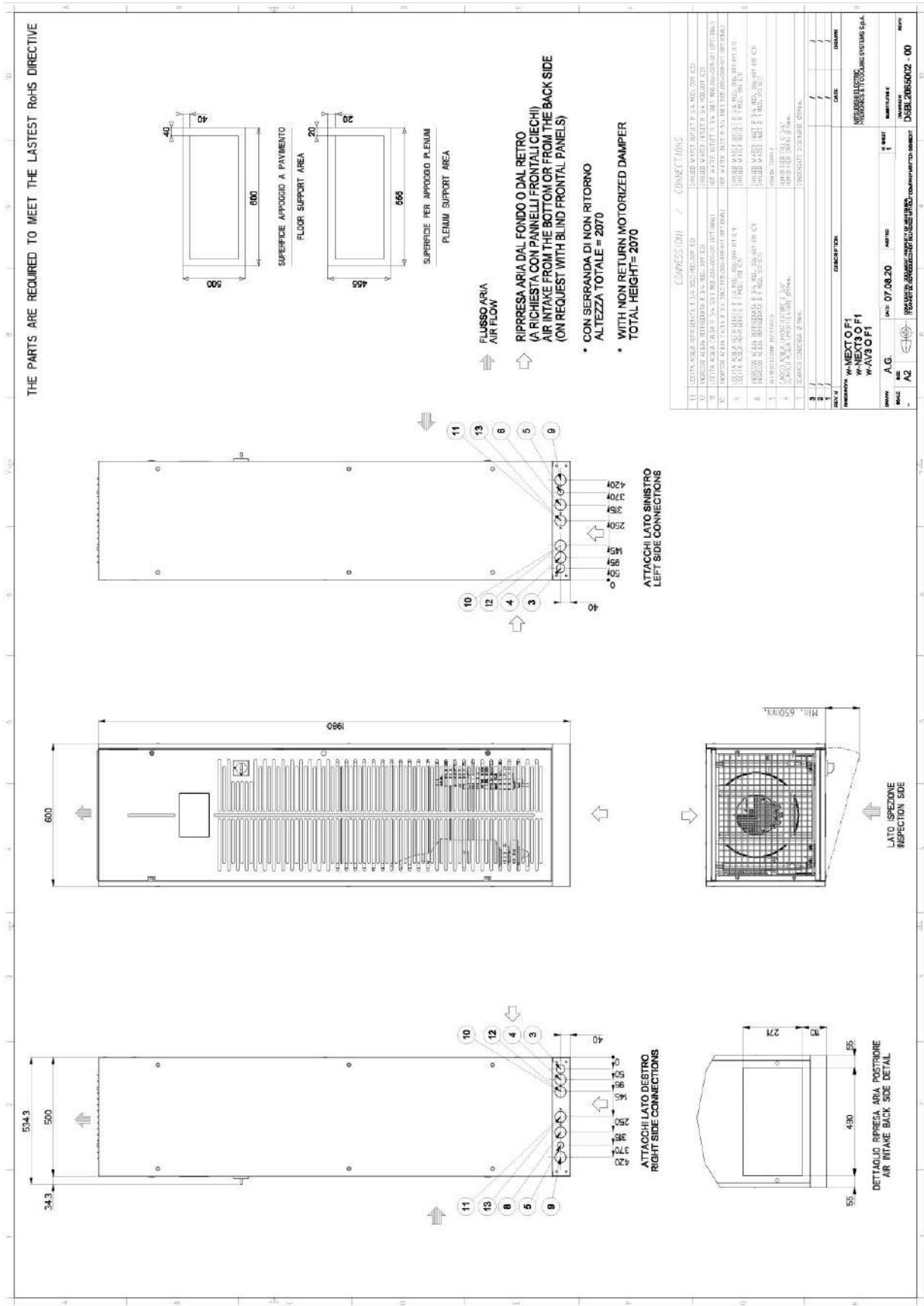

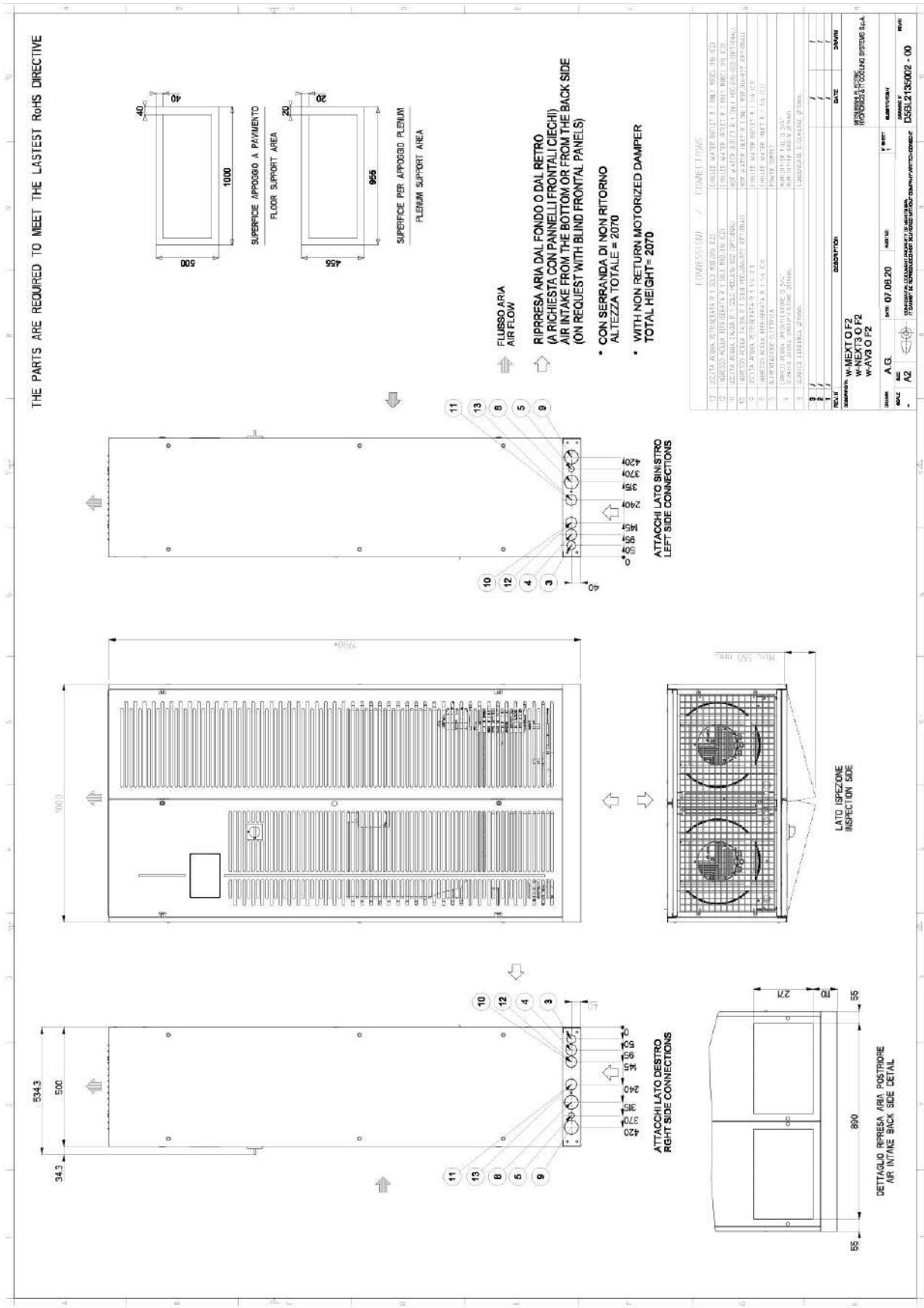

HOLE IN THE RAISED FLOOR FOR DOWNFLOW VERSION

HOLE IN THE RAISED FLOOR WITHOUT SUPPORT FRAME

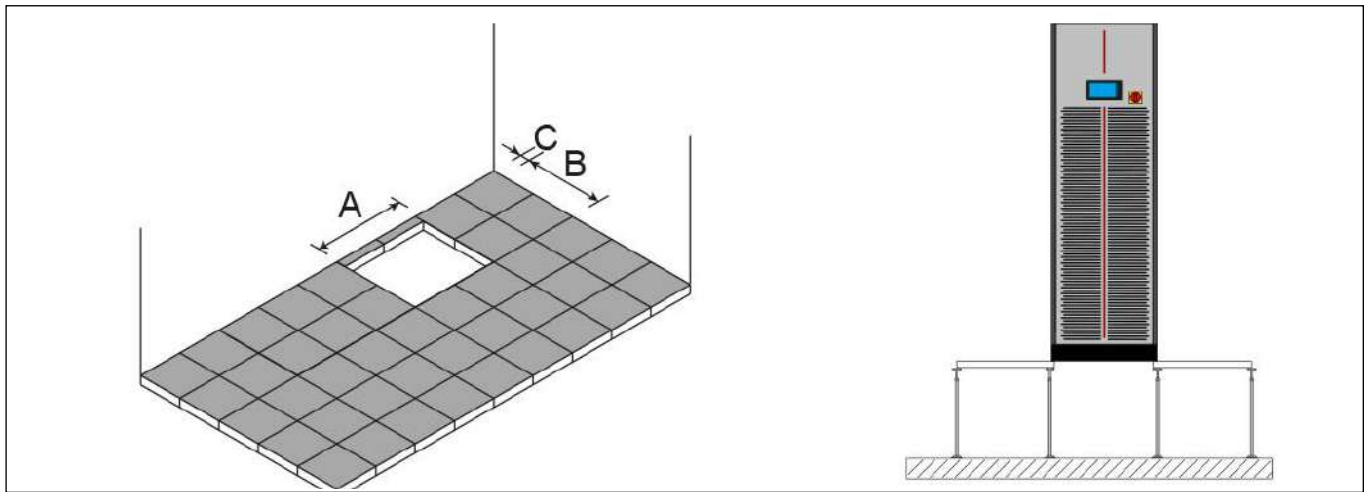

Foresee a hole in the floor with the following dimensions:

SIZE		F1	F2
A	mm	540	940
B	mm	440	440
C	mm	90	90

HOLE IN THE RAISED FLOOR WITH SUPPORT FRAME (OPTION)

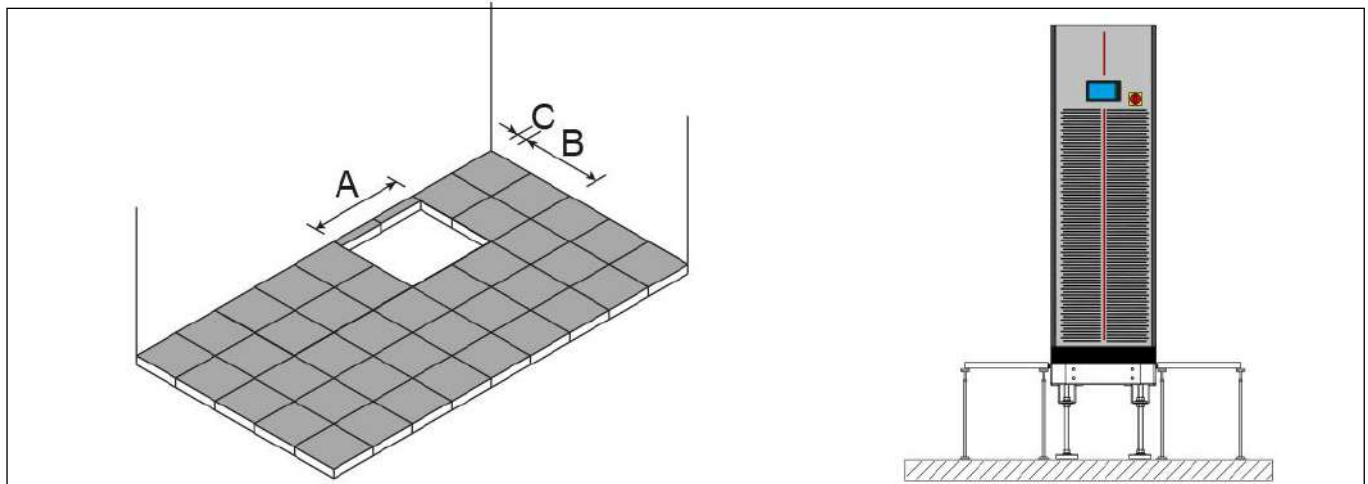

Foresee a hole in the floor with the following dimensions:

SIZE		F1	F2
A	mm	610	1010
B	mm	510	510
C	mm	60	60

EXAMPLE FOR MACHINES NOISE EMISSION CALCULATION

UNDER UNIT WITH DUCT ON AIR INTAKE

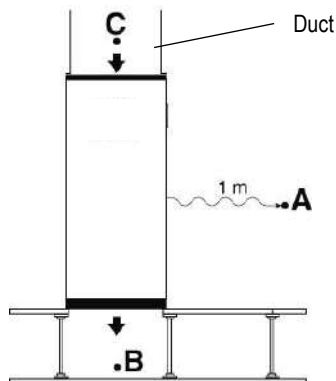

- Lp A = Front side Under catalogue value
- Lp B = Air delivery Under catalogue value
- Lp C = Air intake Under catalogue value
- The points B and C do not influence the point A

UNDER UNIT WITH PLENUM ON AIR DELIVERY

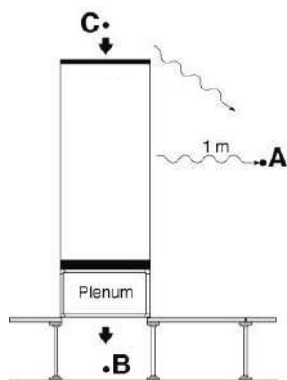

- Lp A = Front side Under catalogue value
- Lp B = Air delivery Under catalogue value –plenum noise reduction
- Lp C = Air intake Under catalogue value
- $Lp A+C = 10 \log_{10} \left(10^{\frac{LpA}{10}} + 10^{\frac{LpC}{10}} \right)$

The point B do not influence the point A

UNDER UNIT WITH PLENUM ON AIR INTAKE

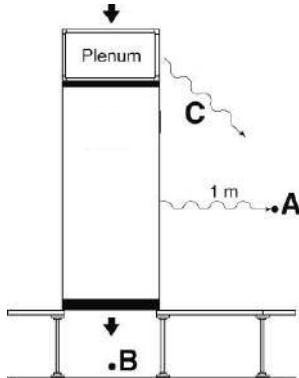

- Lp A = Front side Under catalogue value
- Lp B = Air delivery Under catalogue value
- Lp C = Air intake Under catalogue value – plenum noise reduction
- $Lp A+C = 10 \log_{10} \left(10^{\frac{LpA}{10}} + 10^{\frac{LpC}{10}} \right)$

The point B do not influence the point A

OVER UNIT WITH DUCT

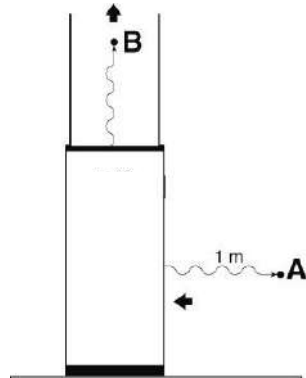

- Lp A = Air intake Over catalogue value
- Lp B = Air delivery Over catalogue value
- The point B do not influence the point A

EXAMPLE FOR MACHINES NOISE EMISSION CALCULATION

OVER UNIT WITH PLENUM ON AIR DELIVERY

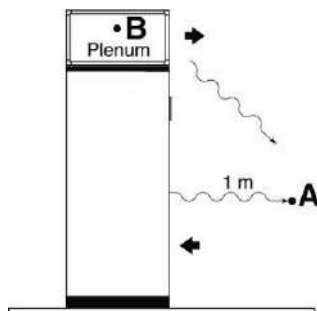

Lp A = Air intake Over catalogue value

Lp B = Air delivery Over catalogue value – plenum noise reduction

$$Lp A+B = 10 \log_{10} \left(10^{\frac{LpA}{10}} + 10^{\frac{LpC}{10}} \right)$$

OVER UNIT WITH DUCT AND PLENUM ON AIR DELIVERY

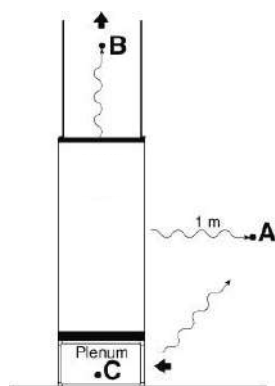

d front panel

Lp A = Radiated Over catalogue value

Lp B = Air delivery Over catalogue value

Lp C = Lp A + 6dB(A) – plenum noise reduction

$$Lp A+C = 10 \log_{10} \left(10^{\frac{LpA}{10}} + 10^{\frac{LpC}{10}} \right)$$

The point B do not influence the point A+C

OVER UNIT WITH DUCT AND PLENUM ON AIR DELIVERY

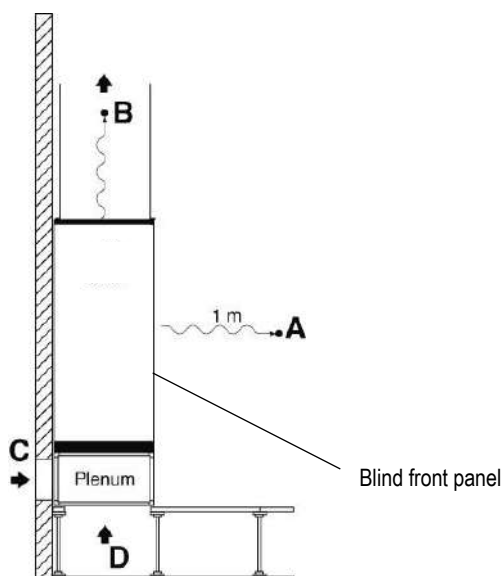

Lp A = Radiated Over catalogue value

Lp B = Air delivery Over catalogue value

Lp C = Lp D = Lp A + 6 dB(A) – plenum noise reduction

The points B, C and D do not influence the point A

IMPORTANT

The declared noise levels are intended in free field conditions.

The noise pressure level of an installed unit is affected by the room acoustic characteristics.

Please consider an average noise increase of +4/+6 dB(A).

SHIPMENT: PACKING DIMENSIONS

Values referred to basic machine. The presence of some accessories increases the weight of machine. The machines are shipped on pallet and covered with carton box. On request packing on pallet covered with shrink wrap and wooden cage. The optional "A532 Damper with spring return" is shipped mounted on the machine and increases its weight and height.

The shipping weight of the machine includes the unit bind bracket, the water leakage detector and, only for Under version, the condensate tray.

STANDARD PACKING DIMENSIONS

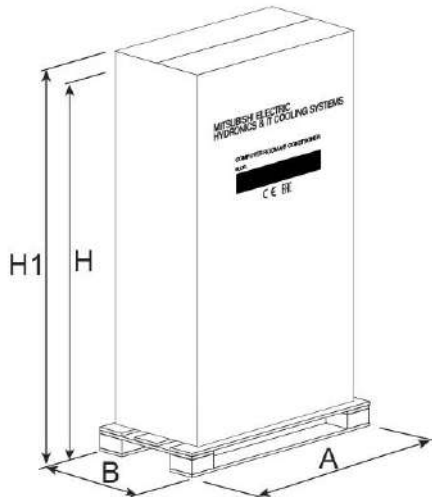

OPTIONAL 9973: WOODEN CAGE PACKING DIMENSIONS

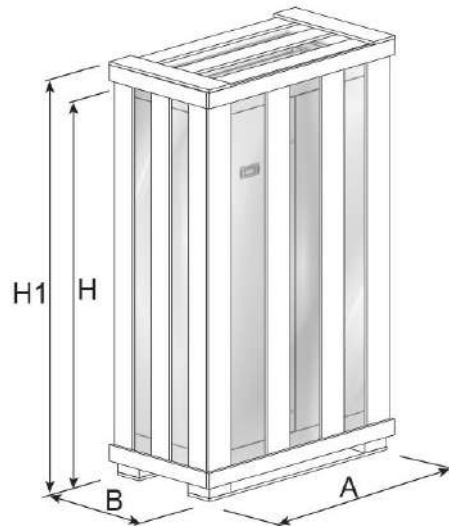

UNDER / OVER Version					
Model	Size	A (mm)	B (mm)	H (mm)	H1 (mm)
006	F1	750	650	2100	2220
009	F1	750	650	2100	2220
011	F1	750	650	2100	2220
013	F1	750	650	2100	2220
016	F2	1100	650	2100	2220
022	F2	1100	650	2100	2220
026	F2	1100	650	2100	2220

DISPLACEMENT version					
Model	Size	A (mm)	B (mm)	H (mm)	H1 (mm)
006	F1	750	650	2220	---
009	F1	750	650	2220	---
011	F1	750	650	2220	---
013	F1	750	650	2220	---
016	F2	1100	650	2220	---
022	F2	1100	650	2220	---
026	F2	1100	650	2220	---

UNDER / OVER Version					
Model	Size	A (mm)	B (mm)	H (mm)	H1 (mm)
006	F1	790	690	2250	2450
009	F1	790	690	2250	2450
011	F1	790	690	2250	2450
013	F1	790	690	2250	2450
016	F2	1140	690	2250	2450
022	F2	1140	690	2250	2450
026	F2	1140	690	2250	2450

DISPLACEMENT version					
Model	Size	A (mm)	B (mm)	H (mm)	H1 (mm)
006	F1	790	690	2450	---
009	F1	790	690	2450	---
011	F1	790	690	2450	---
013	F1	790	690	2450	---
016	F2	1140	690	2450	---
022	F2	1140	690	2450	---
026	F2	1140	690	2450	---

H1 = Machine with optional A532 Damper with spring return

SHIPMENT: SHIPPING WEIGHT

Version		U (UNDER)						
Model		006	009	011	013	016	022	026
Size		F1	F1	F1	F1	F2	F2	F2
PACKING TYPE								
Standard	kg	127	135	143	147	195	205	213
Standard (1)	kg	136	144	152	156	207	217	225
Wooden cage	kg	149	157	165	169	218	228	236
Wooden cage (1)	kg	158	166	174	178	230	240	248

Version		O (OVER)						
Model		006	009	011	013	016	022	026
Size		F1	F1	F1	F1	F2	F2	F2
PACKING TYPE								
Standard	kg	122	128	135	139	188	198	206
Standard (1)	kg	131	137	144	148	200	210	218
Wooden cage	kg	144	150	157	161	211	221	229
Wooden cage (1)	kg	153	159	166	170	223	233	241

Version		DL (DISPLACEMENT)						
Model		006	009	011	013	016	022	026
Size		F1	F1	F1	F1	F2	F2	F2
PACKING TYPE								
Standard	kg	133	138	147	151	204	209	217
Wooden cage	kg	155	160	169	173	227	232	240

(1) Machine with optional A532 Damper with spring return

SHIPMENT: OPTIONALS PACKING DIMENSIONS AND SHIPPING WEIGHT

P041 / P042 / P043: SUPPORT FRAME

The frames are shipped on pallet and covered with shrink wrap.

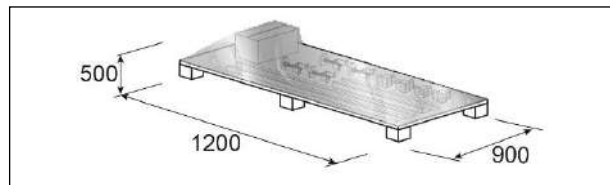

Size		F1	F2
DIMENSIONS			
SHIPPING WEIGHT	kg	29	31

A842: NETWORK ANALYZER

P113: DUAL POWER SUPPLY – External ATS

The optional are shipped in carton box.

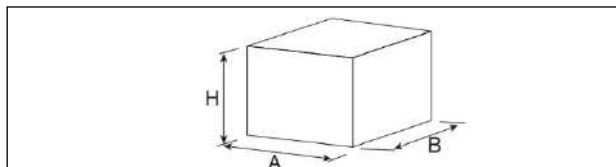

Size	A842 NETWORK ANALYZER		P113 DUAL SUPPLY		
	F1	F2	F1	F2	
DIMENSIONS					
A	mm	410	410	400	400
B	mm	410	410	400	400
H	mm	210	210	210	210
SHIPPING WEIGHT	kg	5	5	12	12

P101: ANTISEISMIC FIXING KIT

The kit is shipped together with the machine.

Size		F1	F2
Weight	kg	2.3	2.3

P011 / P012 – P031 / P032: EMPTY PLENUM

P013 / P014: PLENUM + 3 GRILLES

P015: SILENCED PLENUM

P033: SILENCED INTAKE PLENUM

P016: SILENCED PLENUM + 1 GRILLE

P034: INTAKE FREE COOLING PLENUM

The plenums are shipped on pallet and covered with shrink wrap.

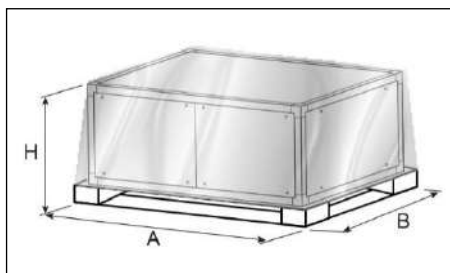

Size		F1	F2
DIMENSIONS			
A	mm	750	1100
B	mm	650	650
H	mm	670	670
SHIPPING WEIGHT			
P011 - Empty plenum "O"	kg	23	31
P012 - Empty plenum CL. A1 (EN 13501-1) "O"	kg	33	44
P031 - Empty plenum "U"	kg	23	31
P032 - Empty plenum CL. A1 (EN 13501-1) "U"	kg	33	44
P013 - Plenum + 3 grilles "O" / "U"	kg	23	31
P014 - Plenum + 3 grilles CL. A1 (EN 13501-1) "O" / "U"	kg	28	38
P015 - Silenced plenum "O" / "U"	kg	29	39
P033 - Silenced intake plenum "U"	kg	29	39
P016 - Silenced plenum + 1 grille + "O" / "U"	kg	23	31
P034 - Intake free cooling plenum "U" / DL	kg	29	40

"O" Over / "U" Under / "DL" Displacement

VALVE PRESSURE DROP CALCULATION AS FUNCTION OF WATER FLOW RATE

Flow coefficient k_V defines the water flow (between 5°C and 40°C) expressed in m³/h that cross a valve with a pressure drop of 1bar (100kPa).

With this data is possible to calculate the localized pressure drop as function of the water flow rate.

$$\Delta P = (Q / k_V)^2$$

ΔP (bar) = localized pressure drop of valve.

Q (m³/h) = water flow rate – it varies according to the desired operating condition.

k_V (m³/h) = valve flow coefficient.

The formula allows to calculate the value of the localized pressure drop (in bar).

The pressure drops values showed on the documentation are supplied in kPa.

Is possible to change from one unit to another through the following conversion.

$$1 \text{ bar} = 100\text{kPa}$$

CALCULATION EXAMPLE OF 2-WAY VALVE PRESSURE DROP IN FUNCTION OF CHILLED WATER COIL WATER FLOW RATE**Model 022 F2 – CHILLED WATER COIL**

Example at nominal conditions. Characteristics referred to entering air at 26°C-40%RH with chilled water temperature 10-15°C - 0% glycol.

Water flow rate: 3.5 m³/h

Valve flow coefficient k_V : 6.3 m³/h

2-way valve for by-pass pressure drop:

$$\Delta P = (Q / k_V)^2 = (3.5 / 6.3)^2 = 0,309 \text{ (bar)} * 100 \text{ (kPa / bar)} = 30.9 \text{ kPa.}$$



for a greener tomorrow

Eco Changes is the Mitsubishi Electric Group's environmental statement, and expresses the Group's stance on environmental management. Through a wide range of businesses, we are helping contribute to the realization of a sustainable society.



MITSUBISHI ELECTRIC HYDRONICS & IT COOLING SYSTEMS S.p.A.

Via Caduti di Cefalonia, 1 - 36061 Bassano del Grappa (VI) Italy
Ph. (+39) 0424 509 500 • Fax (+39) 0424 509 509
www.melcohit.com

